



# Explorer<sup>®</sup> Balances Service Manual





## TABLE OF CONTENTS

	Page No.
1 GETTING STARTED	1
1.1 INTRODUCTION	1
1.2 SERVICE FACILITIES	1
1.3 TOOLS AND TEST EQUIPMENT REQUIRED	2
1.4 SPECIFICATIONS	2
1.5 UNIT CAPACITY AND READABILITY	5
1.6 BALANCE OPERATION	8
1.6.1 Overview of the Controls	8
1.6.2 Main Menu and Principal Functions	9
1.6.3 Menu Navigation	9
1.6.4 Changing Settings	10
1.6.5 Functions and Icons	10
1.7 LEGAL FOR TRADE (LFT)	12
1.8 MENU STRUCTURE	13
1.8.1 User Menu	13
1.8.2 Diagnostics Menu	13
1.9 Securing the Menu and Key Lock menu settings	14
1.10 Display Touch Areas	14
2 DIAGNOSTIC GUIDE	16
2.1 TROUBLESHOOTING	16
2.2 SOFTWARE	16
2.3 DIAGNOSTIC GUIDE	16
3 MAINTENANCE / REPAIR PROCEDURES	20
3.1 PREVENTIVE MAINTENANCE	20
3.2 OPENING THE BALANCE	20
3.2.1 Preparation for Opening Explorer® Models	20
3.2.2 Opening the Terminal Module	22
3.2.3 Opening the Base Module with a Draftshield	24
3.2.4 Opening the Base Module (Top Loader)	26
3.2.5 Opening the Base Module (EX12001, EX24001, EX35001)	28
1. Prepare the balance as instructed above.	28
2. Remove the 2 screws that hold the Spider to the Top Housing and lift off the Spider.	28
3. Remove the 7 screws that hold the Top Housing to the Base.	28
4. Remove the Top Housing	29
3.3 REPLACING THE LOAD CELL (not 12001, 24001 and 35001)	29
3.4 REPLACING THE LOAD CELL (12001, 24001 and 35001)	35
3.5 REMOVING LOAD CELL PROTECTION SCREWS	36
3.6 REPLACING THE PRINTED CIRCUIT BOARD ASSEMBLIES (PCBA)	37
3.2.5 Terminal	37
3.2.6 Base	39
3.7 Replacing the Function Label	42
3.8 Replacing the Touch Panel	43
3.9 Replacing the Feet	43
4 TESTING	45
4.1 TEST MASSES REQUIRED	45
4.2 OPERATIONAL TEST	46
4.3 LOAD CELL TEST USING RAMP	46
4.4 PERFORMANCE TESTS	46

## TABLE OF CONTENTS

---

4.4.1 Precision Test	46
4.4.2 Repeatability Test (non-approved models)	47
4.4.3 Repeatability Test – Approved models	49
4.4.4 Linearity Test	49
4.4.5 Off-Center Load Test	50
5 PARTS LISTS & DIAGRAMS	52
5.1 TERMINAL SPARE PARTS	53
5.2 BASE SPARE PARTS (Non-Draftshield models)	55
5.3 BASE SPARE PARTS (Draftshield models)	57
5.4 BASE SPARE PARTS (EX12001, EX24001, EX35001)	59
5.5 DRAFTSHIELD SPARE PARTS	61
APPENDIX A - USER CALIBRATIONS	63
A.1 SPAN CALIBRATION	63
A.2 LINEARITY CALIBRATION	64
A.3 TOUCH SCREEN CALIBRATION	64
APPENDIX B - DIAGNOSTIC / SERVICE MENU	65
B.1 User Accessible Diagnostics	65
B.2 Service Sub-Menu	66
APPENDIX C – SERVICE TOOL	70
C.1 Balance Commands	71
C.2 RS232 (DB9) Pin Connections	74
C.3 USB Interface	74
APPENDIX D – FIRMWARE UPGRADE VIA USB	70

---

## TABLE OF CONTENTS

---

### LIST OF TABLES

TABLE NO.	TITLE	Page No.
1-1	Specifications.....	2
1-2	Capacity and Readability.....	5
1-3	Menu and Screen Navigation.....	8
1-4	LFT Settings .....	11
1-5	Explorer® User Menu.....	12
2-1	Diagnostic Guide .....	16
4-1	Calibration Mass Values.....	39
4-2	Repeatability Worksheet .....	42
4-3	Linearity Test – Reference and Load Masses .....	43
4-4	Off Center Load Mass Values .....	44
5-1	Terminal Spare Parts.....	48
5-2	Base Spare Parts (Non-Draftshield Models).....	50
5-3	Base Spare Parts (Draftshield Models).....	52
5-4	Draftshield Spare Parts .....	54
B-1	Service Calibration Mass Values .....	60
C-1	Interface Command List .....	74



# 1 GETTING STARTED

## 1.1 INTRODUCTION

This service manual contains the information needed to perform routine maintenance and service on the Ohaus Explorer® Series balances. Familiarity with the balance's Instruction Manual is assumed. The contents of this manual are contained in five chapters:

**Chapter 1 - Getting Started** – Contains information on service facilities, tools, specifications, and the mechanical and electronic functions of the balance.

**Chapter 2 - Troubleshooting** – Contains a diagnostic guide and error code table.

**Chapter 3 - Maintenance Procedures** – Contains preventive maintenance procedures and disassembly, repair and replacement procedures.

**Chapter 4 - Testing** – Contains a list of required test masses, an operational test, segment display test, performance tests and adjustments.

**Chapter 5 - Drawings and Parts Lists** – Contains exploded views of Explorer® balances identifying all serviceable components.

**Appendix A - User Calibrations** – Explains user calibration procedures that may need to be performed during service.

**Appendix B - Service Calibration** – Describes the Service Menu and sub-menus, which allow authorized service personnel to see Ramp readings and perform service calibrations.

**Appendix C - Software Service Tool Instructions** – Used to re-configure the balance after replacing a Printed Circuit Board or Load-cell.

## 1.2 SERVICE FACILITIES

To service a balance, the service area should meet the following requirements:

- Should be temperature controlled and meet balance specifications for temperature environmental requirements.
- Must be free of vibrations such as fork lift trucks close by, large motors, air currents or drafts from air conditioning/heating ducts, open windows, people walking by, fans, etc.
- Area must be clean and free of excessive dust.
- Work surface must be stable and level.
- Balance must not be exposed to direct sunlight or radiating heat sources.
- Handle all electronic assemblies with appropriate Electro-Static protection.

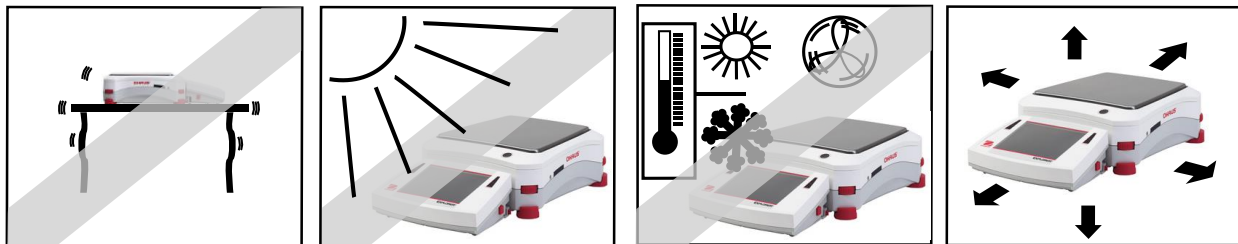

**1.3 TOOLS AND TEST EQUIPMENT REQUIRED**

- Common hand tools are sufficient to disassemble the Explorer® balances.
- A PC running Microsoft Windows XP or later.
- Explorer® Software Service Tool, PN 83032124
- RS232 Cable – Balance to PC PN 80500525
- Digital voltmeter (DVM) with an input impedance of at least 10 meg-ohms at 1 volt DC.
- Masses as shown in Table 4-1.

**1.4 SPECIFICATIONS**

Specifications for the Ohaus Explorer® Balances are listed in Table 1-1. When a balance has been serviced, it must meet the specifications listed in the table. Before servicing the balance, determine what specifications are not met.

**Special Note regarding Approved balances:**

The specifications for the approved balances below are only for initial testing. These balances must be tested according to the requirements of the local Weights and Measures authority. Before returning the balance to service an approved representative of the local Weights and Measures authority must certify the balance.

Ambient conditions

- Indoor use only
- Altitude: Up to 2000 m
- Specified Temperature range: 10°C to 30°C
- Humidity: maximum relative humidity 80 % for temperatures up to 31°C, decreasing linearly to 50% relative humidity at 40°C
- Mains supply voltage fluctuations: up to -15% to +10% of the nominal voltage
- Over voltage category II
- Pollution degree: 2
- Operability is assured at ambient temperatures between 5°C and 40°C

**TABLE 1-1 SPECIFICATIONS**

**EX with Draftshield (non-Approved)**

Model	EX124	EX224	EX324	EX223	EX423	EX623	EX1103
Capacity (g)	120	220	320	220	420	620	1100
Readability d (g)	0.0001	0.0001	0.0001	0.001	0.001	0.001	0.001
Repeatability (g) (1d)	0.0001	0.0001	0.0001	0.001	0.001	0.001	0.001
Linearity (g) (2d)	0.0002	0.0002	0.0002	0.002	0.002	0.002	0.002
OCL (g) (4.5d) see Table 4-4 for load	0.00045	0.00045	0.00045	0.0045	0.0045	0.0045	0.0045
Zero Drift (g/°C)	0.0001	0.0001	0.0001	0.001	0.001	0.001	0.001
Span Sensitivity (g/°C)	0.0001	0.0001	0.0001	0.001	0.001	0.001	0.001



**EX without Draftshield (non-Approved)**

Model	EX2202	EX4202	EX6202	EX10202	EX6201	EX10201
Capacity (g)	2200	4200	6200	10,200	6200	10,200
Readability d (g)	0.01	0.01	0.01	0.01	0.1	0.1
Repeatability (g) (1d)	0.01	0.01	0.01	0.01	0.1	0.1
Linearity (g)	0.02	0.02	0.02	0.02	0.1	0.1
OCL (g) see Table 4-4 for load	0.045	0.045	0.045	0.045	0.35	0.35
Zero Drift (g/°C)	0.01	0.01	0.01	0.01	0.1	0.1
Span Sensitivity (g/°C)	0.01	0.01	0.01	0.01	0.1	0.1

**EX (EC / OIML Type Approved)**

These models must meet all EC / OIML requirements.

Model	EX224M	EX324M	EX423M	EX1103M	EX4202M	EX10202M	EX10201M
Capacity (max) (g)	220	320	420	1100	4200	10200	10200
Readability d (g)	0.0001	0.0001	0.001	0.001	0.01	0.01	0.1
Ver. Interval e (g)	0.001	0.001	0.01	0.01	0.1	0.1	0.1
LFT Class	I	I	II	I	II	I	I
Repeatability (10 times each load) (load / MPE)	100g / 0.001g 200g / 0.001g	150g / 0.001g 300g / 0.0015g	200g / 0.01g 400g / 0.015g	500g / 0.005g 1000g / 0.01g	2000g / 0.1g 4000g / 0.15g	5000g / 0.05g 10000g / 0.1g	5000g / 0.05g 10000g / 0.1g
Linearity (g) reference only	0.0002	0.0002	0.003	0.0024	0.03	0.024	0.024
OCL (load / MPE) see Table 4-5 for load	100g / ± 0.001g	100g / ± 0.001g	200g / ± 0.01g	500g / ± 0.005g	2000g / ± 0.1g	3500g / ± 0.05g	3500g / ± 0.05g
Zero Drift (1e / 1°C)	0.001g / 1°C	0.001g / 1°C	0.01g / 1°C	0.01g / 1°C	0.1g / 1°C	0.1g / 1°C	0.1g / 1°C
Span Sensitivity (MPE /°C @ max)	0.0015g	0.0015g	0.015g	0.01g	0.15g	0.1g	0.1g

## CHAPTER 1 - GETTING STARTED

### EX (NTEP / MC Type Approved)

These models must meet all NTEP and Canadian Weight & Measures requirements.

Model	EX224N	EX324N	EX423N	EX1103N	EX4202N	EX10202N	EX10201N
Capacity (g)	220	320	420	1100	4200	10200	10200
Readability d (g)	0.0001	0.0001	0.001	0.001	0.01	0.01	0.1
Ver. Interval e (g)	0.001	0.001	0.01	0.01	0.1	0.1	1
LFT Class	I	I	II	I	II	I	I
Repeatability (10 times each load) (load / MPE)	100g / 0.001g	150g / 0.001g	200g / 0.01g	500g / 0.005g	2000g / 0.1g	5000g / 0.05g	5000g / 0.05g
	200g / 0.001g	300g / 0.0015g	400g / 0.015g	1000g / 0.01g	4000g / 0.15g	10000g / 0.1g	10000g / 0.1g
Linearity (g) reference only	0.0002	0.0002	0.003	0.0024	0.03	0.024	0.024
OCL (load / MPE) see Table 4-5 for load	100g / ± 0.001g	100g / ± 0.001g	200g / ± 0.01g	500g / ± 0.005g	2000g / ± 0.1g	3500g / ± 0.05g	3500g / ± 0.05g
Zero Drift (1e / 1°C)	0.001g / 5°C	0.001g / 5°C	0.01g / 5°C	0.01g / 5°C	0.1g / 5°C	0.1g / 5°C	0.1g / 5°C
Span Sensitivity (MPE /°C @ max)	0.0015g	0.0015g	0.015g	0.01g	0.15g	0.1g	0.1g

### EX High Capacity

Model	EX12001	EX24001	EX35001
Capacity (max) (g)	12000 g	24000 g	35000 g
Readability d (g)	0.1 g		
Ver. Interval e (g)	1g		
LFT Class	II		
Repeatability (10 times each load) (load / MPE)	1d		
Linearity (g) reference only	±0.2 g		

**AutoDoor models**

Model	EX124AD	EX224AD	EX324AD
Capacity (g)	120	220	320
Readability d (g)	0.0001	0.0001	0.0001
Repeatability (g) (1d)	0.0001	0.001	0.001
Linearity (g) (2d)	0.0002	0.0002	0.0002
OCL (g) (4.5d) see Table 4-4 for load	0.00045	100g / 0.001g 200g / 0.001g	150g / 0.001g 300g / 0.0015g
Zero Drift (g/°C)	0.0001	0.0002	0.0002
Span Sensitivity (g/°C)	0.0001	100g / ± 0.001g	100g / ± 0.001g

**ExCal models**

Model	EX223E	EX423E	EX2202E	EX4202E	EX6202E	EX6201E
Capacity (g)	220	420	320	4200	6200	6200
Readability d (g)	0.001	0.001	0.0001	0.01	0.01	0.1
Repeatability (g) (1d)	0.001	0.001	0.001	0.01	0.01	0.1
Linearity (g) (2d)	0.002	0.002	0.02	0.02	0.02	0.1
OCL (g) (4.5d) see Table 4-4 for load	0.0045	0.0045	150g / 0.001g 300g / 0.0015g	0.045	0.045	0.35
Zero Drift (g/°C)	0.001	0.001	0.0002	0.01	0.01	0.1
Span Sensitivity (g/°C)	0.001	0.001	100g / ± 0.001g	0.01	0.01	0.1

Note: MPE - Maximum Permissible Error

MPE	For loads (m) in verified units (e)	
	Class I	Class II
± 0.5 e	0 ≤ m ≤ 50,000	0 ≤ m ≤ 5000
± 1 e	50,000 < m ≤ 200,000	5000 < m ≤ 20,000
± 1.5 e	200,000 < m	20,000 < m ≤ 1000,000

Maximum errors for balances in usage are twice the acceptable errors for initial verification.

**CHAPTER 1 - GETTING STARTED**

**UNIT CAPACITY AND READABILITY**

The capacity and readability of the available units of measure are listed in Table 1-2.

**TABLE 1-2 UNIT CAPACITY (Max) AND READABILITY (d)**

Units	EX124	EX224	EX324	EX223	EX423	EX623	EX1103
grams	120.0000	220.0000	320.0000	620.000	420.000	620.000	1100.000
	0.0001	0.0001	0.0001	0.001	0.001	0.001	0.001
lb	n/a	n/a	n/a	0.485015	0.925940	1.366865	2.425085
	n/a	n/a	n/a	0.000005	0.000005	0.000005	0.000005
dwt	77.1618	141.4633	205.7648	141.463	270.066	398.669	707.316
	0.0001	0.0001	0.0001	0.001	0.001	0.001	0.001
t(HK)	3.206070	5.87795	8.549520	5.87780	11.22125	16.56470	29.38900
	0.000005	0.000005	0.000005	0.00005	0.00005	0.00005	0.00005
t(Sing)	3.174655	5.820205	8.465750	5.82020	11.11130	16.40240	29.10100
	0.000005	0.000005	0.000005	0.00005	0.00005	0.00005	0.00005
t(ROT)	3.200000	5.866665	8.533335	5.86665	11.20000	16.53335	29.33335
	0.000005	0.000005	0.000005	0.00005	0.00005	0.00005	0.00005
ti	7.34874	13.47269	19.59664	13.4727	25.7206	37.9685	67.3635
	0.00001	0.00001	0.00001	0.0001	0.0001	0.0001	0.0001
kg	n/a			0.220000	0.420000	0.620000	1.100000
	n/a			0.000001	0.000001	0.000001	0.000001
ozt	3.868090	7.073165	10.288240	7.07315	13.50330	19.93345	35.36585
	0.000005	0.000005	0.000005	0.00005	0.00005	0.00005	0.00005
m	32.00000	58.6665	85.3335	58.6665	112.0000	165.3335	293.3335
	0.00005	0.00005	0.00005	0.0005	0.0005	0.0005	0.0005
N	1.176798	2.157463	3.138128	2.15746	4.11879	6.08013	10.78733
	0.000001	0.000001	0.000001	0.00001	0.00001	0.00001	0.00001
oz	4.232875	7.760270	11.287665	7.76025	14.81505	21.86985	38.80135
	0.000005	0.000005	0.000005	0.00005	0.00005	0.00005	0.00005
ct	600.0000	1100.000	1600.000	1100.000	2100.000	3100.000	5500.000
	0.0005	0.0005	0.0005	0.005	0.005	0.005	0.005
GN	1851.882	3395.118	4938.354	3395.12	6481.58	9568.06	16975.60
	0.002	0.002	0.002	0.02	0.02	0.02	0.02
msg	26.03985	47.73975	69.439650	47.7400	91.1395	134.5395	238.6990
	0.00005	0.00005	0.00005	0.0005	0.0005	0.0005	0.0005
baht	7.91557	14.51187	21.10818	14.5119	27.7045	40.8971	72.5594
	0.00001	0.00001	0.00001	0.0001	0.0001	0.0001	0.0001
custom(3)							
tola	10.28824	18.86177	27.43530	18.8619	36.0088	53.1559	94.3089
	0.00001	0.00001	0.00001	0.0001	0.0001	0.0001	0.0001
mg	120000.0	220000.0	320000.0	220000	420000	620000	1100000
	0.1	0.1	0.1	1	1	1	1

**CHAPTER 1 - GETTING STARTED**

<b>Units</b>	<b>EX2202</b>	<b>EX4202</b>	<b>EX6202</b>	<b>EX10202</b>	<b>EX6201</b>	<b>EX10201</b>	<b>EX12001</b>	<b>EX24001</b>	<b>EX35001</b>
grams	2200.00	4200.00	6200.00	11000.00	6200.0	11000.0	12000.0	24000.0	35000.0
	0.01	0.01	0.01	0.01	0.1	0.1	0.1	0.1	0.1
lb	4.85015	9.25940	13.66865	22.48715	13.6685	22.4870	26.45547	52.91094	77.16179
	0.00005	0.00005	0.00005	0.00005	0.0005	0.0005	0.0005	0.0005	0.0005
dwt	1414.63	2700.66	3986.69	6558.75	3986.7	6558.8	7 716.2	15 432.4	22 506.0
	0.01	0.01	0.01	0.01	0.1	0.1	0.1	0.1	0.1
t(HK)	58.770	112.2125	165.6470	272.5160	165.645	272.515	320.64	641.28	935.20
	0.0005	0.0005	0.0005	0.0005	0.005	0.005	0.005	0.005	0.005
t(Sing)	58.2020	111.1130	164.0240	269.8460	164.025	269.845	317.52	635.04	926.1
	0.0005	0.0005	0.0005	0.0005	0.005	0.005	0.005	0.005	0.005
t(ROT)	58.6665	112.0000	165.3335	272.0000	165.335	272.000	320.0000	640.0000	933.3306
	0.0005	0.0005	0.0005	0.0005	0.005	0.005	0.005	0.005	0.005
ti	134.727	257.206	379.685	624.643	379.68	624.64	735	1470	2143.75
	0.001	0.001	0.001	0.001	0.01	0.01	0.01	0.01	0.01
kg	2.20000	4.20000	6.20000	10.20000	6.2000	10.2000	12.000	24.000	35.000
	0.00001	0.00001	0.00001	0.00001	0.0001	0.0001	0.0001	0.0001	0.0001
ozt	70.7315	135.0330	199.3345	327.9375	199.335	327.940	385.809	771.618	1 125.276
	0.0005	0.0005	0.0005	0.0005	0.005	0.005	0.005	0.005	0.005
m	586.665	1120.000	1653.335	2720.000	1653.35	2720.00	3200.40	6400.80	9334.5
	0.005	0.005	0.005	0.005	0.05	0.05	0.05	0.05	0.05
N	21.5746	41.1879	60.8012	100.0278	60.801	100.028	117.696	235.392	343.28
	0.0001	0.0001	0.0001	0.0001	0.001	0.001	0.001	0.001	0.001
oz	77.6025	148.1505	218.6985	359.7946	218.700	359.795	423.288	846.575	1 234.589
	0.0005	0.0005	0.0005	0.0005	0.005	0.0005	0.0005	0.0005	0.0005
ct	11000.00	21000.00	31000.00	510000.00	31000.0	510000.0	60000.0	120000.0	175000.0
	0.05	0.05	0.05	0.05	0.5	0.05	0.05	0.05	0.05
GN	33951.2	64815.8	95680.6	157410.0	95680	157410	185208	370416	540190
	0.2	0.2	0.2	0.2	2	2	2	2	2
msg	477.400	911.395	1345.395	2213.390	1345.40	2213.40	2604.60	5209.2	7596.75
	0.005	0.005	0.005	0.005	0.05	0.05	0.05	0.05	0.05
baht	145.119	277.045	408.971	672.823	408.97	672.82	800.00	1600.00	2333.33
	0.001	0.001	0.001	0.001	0.01	0.001	0.001	0.001	0.001
custom(3)									
tola	188.618	360.088	531.559	874.500	531.56	874.50	1028.82	2057.65	3000.74
	0.001	0.001	0.001	0.001	0.01	0.01	0.01	0.01	0.01
mg	22000000	4200000	6200000	10200000	6200000	10200000	12000000	24000000	35000000
	10	10	10	10	100	100	100	100	100

1.5 BALANCE OPERATION

The Explorer® is a very simple to use yet sophisticated balance. Please refer to the Explorer® Instruction Manual for complete information on the set up and use of the balance.

1.5.1 Overview of the Controls

The screenshot shows the Explorer balance control interface. At the top, there are three touchable elements: a wrench icon labeled 'Touch to access application setup menu', a 'Library' dropdown menu labeled 'Touch to change applications', and an information icon labeled 'Touch to access available libraries'. Below these is an instructional message: 'Place sample on the pan. Press Accumulate to add to the total.' The main display shows a large weight of '1077.54 g' with a unit indicator 'g' to its right. Below the weight is a 'Total: 19353.92 g' and a 'Capacity Guide' bar showing '0' out of '10200.00'. A data table follows:
 

Samples:	5	Minimum:	3822.31 g	Gross:	1077.54 g
Average:	3870.78 g	Maximum:	3903.01 g	Net:	1077.54 g
$\sigma$ (stdev):	26.37 g	Range:	80.70 g	Tare:	0.00 g











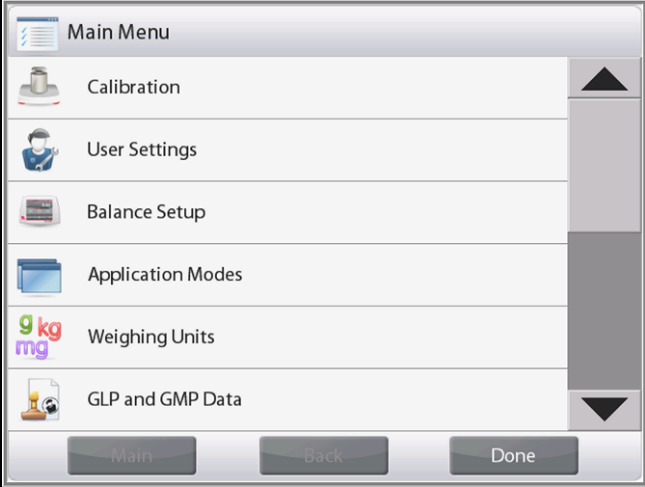



 Below the table are three buttons: 'Tare', 'Accumulate', and 'Clear Total'. At the bottom is a row of icons: 'Standby', 'Print', 'Applications', 'Sensors', 'AutoCal™', 'Menu', and 'More...'.
 

Annotations on the right side of the screenshot include: 'Touch for information menu' pointing to the info icon; 'Touch unit indicator to change weighing unit' pointing to the 'g' unit; 'Capacity or Status Guides: Vary by application' pointing to the capacity bar; and 'Application Buttons: Functions vary by application' pointing to the 'Tare', 'Accumulate', and 'Clear Total' buttons.

Annotations on the left side include: 'Instructional Messages' pointing to the top instruction; 'Stability (\*), Net (NET), Gross (G) and/or center of zero (>0<) indicators' pointing to the asterisk and weight display; 'Result Fields: Information varies by application' pointing to the data table; and 'Touch icons to perform specific functions or access other functions' pointing to the bottom icon row.

1.5.2 Main Menu and Principal Functions

TABLE 1-3 MENU AND SCREEN NAVIGATION

Touch <b>Menu</b> to open the menu list. Touch and drag the <b>Scroll bar</b> to view additional items.			
	<b>Calibration:</b> Touch to view calibration options.		<b>User Settings:</b> Touch to view user preferences.
	<b>Balance Setup:</b> Touch to view balance settings.		<b>Application Modes:</b> Touch to view application modes.
	<b>Weighing Units:</b> Touch to view weighing units.		<b>GLP and GMP Data:</b> Insert user data for traceability.
	<b>Diagnostics:</b> Touch to view library items.		<b>Factory Reset:</b> Touch to view diagnostics list.
	<b>Communication:</b> Touch to view COM Device Settings and Print Settings.		<b>Lockout:</b> Touch to view diagnostics list.
	<b>Library:</b> Touch to view library items.		<b>Information:</b> Touch to view list of topics.
	<b>I/O Settings:</b> Touch to view library items.		

1.5.3 Menu Navigation

All menu navigation is performed by touching the display. To enter the Menu, touch **Menu** from any Application Home screen. The Main menu appears, with buttons for **Main**, **Back** and **Done**. Continue touching the appropriate list item to navigate to the Menu items or touch a button to change location.

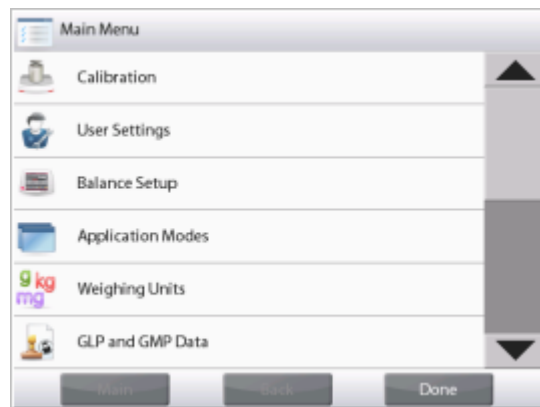
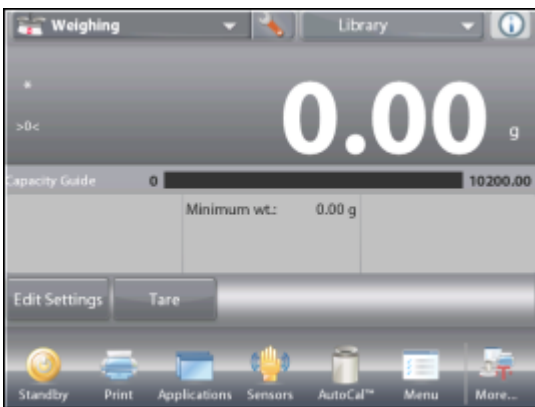

### 1.5.4 Changing Settings

These Icons are available to setup and operate the Balance. Refer to the Instruction Manual for more information.

To change a menu setting, navigate to that setting using the following steps:

#### Enter the Menu

From any Application screen, Touch **Menu**.  
The Main Menu List appears on the display.

#### Select the Sub-Menu

Scroll down to the selected item of the Main Menu List and touch it. The Sub-Menu appears.

#### Select the Menu Item

Continue until the desired setting is chosen in the Menu list. Touch the setting to change it. The changed setting will be displayed as highlighted for 2 seconds to confirm the changed value.



Exit the Menu and Return to the Current Application

After the setting is confirmed, touch **Home** to return to the Application.

**Note:** at any time the **Main**, **Back** & **Done** buttons can be touched to navigate to the desired area of the menu or return to the current Application.

### 1.5.5 Functions and Icons

These Icons are available to setup and operate the Balance. Refer to the Instruction Manual for more information.



#### Standby

Touch **Standby** to shut down the display.

**Note:** After initial start-up, in Standby your balance needs no warm-up time and is immediately available for weighing by touching the Start-up icon.



#### Printing Data

Touch **Print** to send the displayed value to a printer or computer via the active COM port.

**Note:** Ensure proper setup of connections, printing and interface parameters.

**Note:** Data may also be printed using the Touchless Sensors by configuring these for Printing. Data may also be printed using the P command from a computer connected to the COM port.



#### Applications

The balance can be configured to operate in various Application modes.

Touch Applications to choose – or the top button in the Application area.



#### TouchLess Sensor Status

Explorer® balances have four **TouchLess** sensors that can be assigned a unique function when activated (e.g., zero, print, tare, etc).

To assign a task for each TouchLess sensor, press **TouchLess Sensor**.

**Note:** To activate a sensor, move an object over it (from a distance of 1-2 inches or 3 cm). The sensor shows a green light and beeps when activated. If the sensor cannot be activated (sensor is disabled during certain instances, like when the Menu is displayed) the sensor shows a red light.





**AutoCal™**

When AutoCal is ON, the balance performs a self-calibration following a temperature change of 1.5° C (for 4-place and 3-place models) and 6.5° C for (for 2-place balances), or every 11 hours. Touch AutoCal to change the status. (Default status is ON.)

**Note:** Not available in ExCal



**Menu**

Touch **Menu** to enter the balance's menu list.



**More...**

Touch More to access Level Assist, Zero, Tare, Units, Pretare, Cal Test, Calculator, and Stopwatch.



**Zero Operation**

Remove the load from the pan and touch **Zero** to set the display to zero. When weighing pan is empty, the >0< indicator turns on when the measurement is within  $\pm \frac{1}{4}$  division (d) of the zero setting.

**Note:** The balance also features Auto Zero Tracking (AZT) that automatically maintains a Center of Zero within the tolerances set in the AZT menu (see Balance Settings).



**Weighing Units**

The balance can be configured to measure in a variety of weighing units, including three (3) custom units. Touch **Units** to choose from the displayed list. (*Scroll down to see all options.*)

**Note:** The active weighing Unit can also be accessed by touching the unit area of the Main Display line; If a unit is not displayed in the list, it must first be turned on via the User Menu.

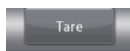

**Taring a Container**

Taring sets the weight of a container as zero, so only the weight of objects held in the container (net weight) is displayed.

or



**Manual Tare** – Place the empty container on the pan and touch **Tare** when stable.

Add material to the container. The net weight of the material is displayed.

To clear the Tare value, remove the container from the pan and touch **Tare**.



**Preset Tare**

A preset tare may be entered using a computer connected to the COM port. To enter a Preset Tare, send the xT command to the balance where x is the value in grams. Enter a value of 0 to clear the Preset Tare. The display will show the PT symbol and the tare value as a negative number.



**Auto Tare**

Automatically tares the first item placed on the pan.

To use Auto Tare set it to ON in the Balance Setup menu. The message line shows **Place container**. When the container is placed on the pan, it is automatically tared and the Net weight is displayed. The Tare value is automatically cleared when the container is removed from the pan.



**Calibration Test**

Calibration Test is used to compare a known calibration weight against the last stored span calibration data.



**Internal Calibration**

Touch **Internal Calibration** to initiate a calibration using the internal weight.



**Stopwatch**

To use the built-in stopwatch application, touch **Stopwatch**. A countdown timer with interval (lap) timer is available.



**Calculator**

To use the built-in calculator application, touch **Calculator**. The calculator has four functions, addition, subtraction, multiplication and division.



**Logout**

Used for User logout and return to User Login screen. This feature is only active if a user profile has been created.





**1.6 LEGAL FOR TRADE (LFT)**

When the balance is set for LFT (on “M” and “N” models), the following menu settings cannot be accessed / changed: Calibration, Mode and Units. Type approved operation may force some balance settings as required by the approval agency.

In non-approved models the Menu lock switch may also limit access to certain menu items based on the Balance lock out settings. The Service Menu (see section 1.8.2) is not available when the switch is “on”.

To regain access to the locked menu settings, move the Menu lock switch to the rear, which turns LFT off.

**TABLE 1-4 LFT SETTINGS**

	<p><b>Legal For Trade</b> Use this menu to set the Legal for Trade status. <b>OFF</b> = standard operation. <b>ON</b> = operation complies with Weights and Measures regulations.</p> <p>When Legal for Trade is set to ON, the menu settings are affected as follows:</p> <p><b>Calibration Menu</b></p> <ul style="list-style-type: none"> <li>• AutoCal internal Calibration, Automatic Calibration, and Calibration Test functions are available.</li> <li>• All other functions are hidden.</li> </ul> <p><b>Balance Setup Menu</b></p> <ul style="list-style-type: none"> <li>• Stability Indicator Range is locked at 1 Division.</li> <li>• Auto Zero Tracking is limited to 0.5 Division and OFF.</li> <li>• Auto Tare and Gross Indicator are locked at their current setting.</li> <li>• Graduations is locked at 1 Division.</li> </ul> <p><b>Communication Menu</b></p> <ul style="list-style-type: none"> <li>• Stable Weight Only is locked ON.</li> <li>• Numeric Value Only is locked OFF.</li> <li>• Auto print mode selections are limited to OFF, On Stability, and Interval. Continuous is not available.</li> </ul>
  <p>Explorer switch</p>  <p>Explorer High Capacity</p>	<p><b>Note:</b> The security switch under the Base must be in the locked position to set Legal for Trade to ON. The security switch must be in the unlocked position to set Legal for Trade to OFF.</p>

After the Menu Lock setting has been turned off, the balance must be inspected in accordance with local weights and measures regulations before it can be used in LFT mode again. Local authorities may secure the switch using paper seals, wire seals or plastic ties.

**Note:** “M” and “N” models- When the Menu Lock switch is set to “on” certain menu items will be forced to the required setting and the required menus will be locked.













## 1.7 MENU STRUCTURE

Programmable features of the Explorer® are accessed through a graphical interface using the Display Touch Panel. By touching an item on the display a further set of options will appear.

### 1.7.1 User Menu

For more detail on using the menu, see the Explorer® Instruction Manual.

TABLE 1-5 EXPLORER® USER MENU

						
Calibration	User Settings	Balance Setup	Applications	Weighing Units	GLP and GMP Data	Communication
						
Library	I/O Settings	Diagnostics	Factory Reset	Lockout	Information	

### 1.7.2 Diagnostics Menu

This menu used to access the balances Service Menu and also can be used to verify the operation of some features.



**Level Bubble Light (not available in EX12001, EX24001 and EX35001)**

To verify proper operation of the illuminated Level Bubble. When selected, this light should blink.



**Draft Shield Light**

To verify proper operation of the Draft Shield Light. When selected, this light should blink.



**Sensors**

To verify proper operation of each Touchless Sensor. When operated, each sensor should light and make a sound.



**Automatic draftshield door**

To verify proper operation of each Automatic Draftshield Door.

When operated, each door should move automatically.

**Note:** Only for Automatic draftshield door models

**Service Menu**

The Service Menu is intended for use by service personnel. A password is required to access this menu; “Explorer” (SW 1.10) or “OHAUS” (SW 1.03).

The Service menu includes three sub-Menus; Ramp, Span Calibration and Internal Calibration. See **Appendix B** for additional information.



### 1.8 Securing the Menu and Key Lock menu settings

A slide switch is used to secure the Menu Lock and Key Lock menu settings. When the switch is set to the ON position, the Menu Lock and Key Lock menu settings may be viewed but not changed. This switch is located under the Base.

Set the position of the switch to ON by sliding the external Lock Switch to LOCKED.

When the switch is in the ON position, the start up display includes the LOCK ON message.

**Note:** This switch is also used in conjunction with the Legal for Trade menu item. When the Legal for Trade menu is set to ON, the switch must be set to the ON position to prevent calibration and changes to metrologically significant settings.

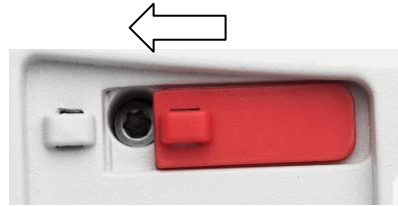

Explorer Switch



Explorer High Capacity (EX12001, EX24001, EX35001)

### 1.9 Display Touch Areas

The display touch areas that are active will change with the screen layout. Button areas will always be active but some areas will require familiarity with the Explorer® man-machine interface.

Application with Single line:

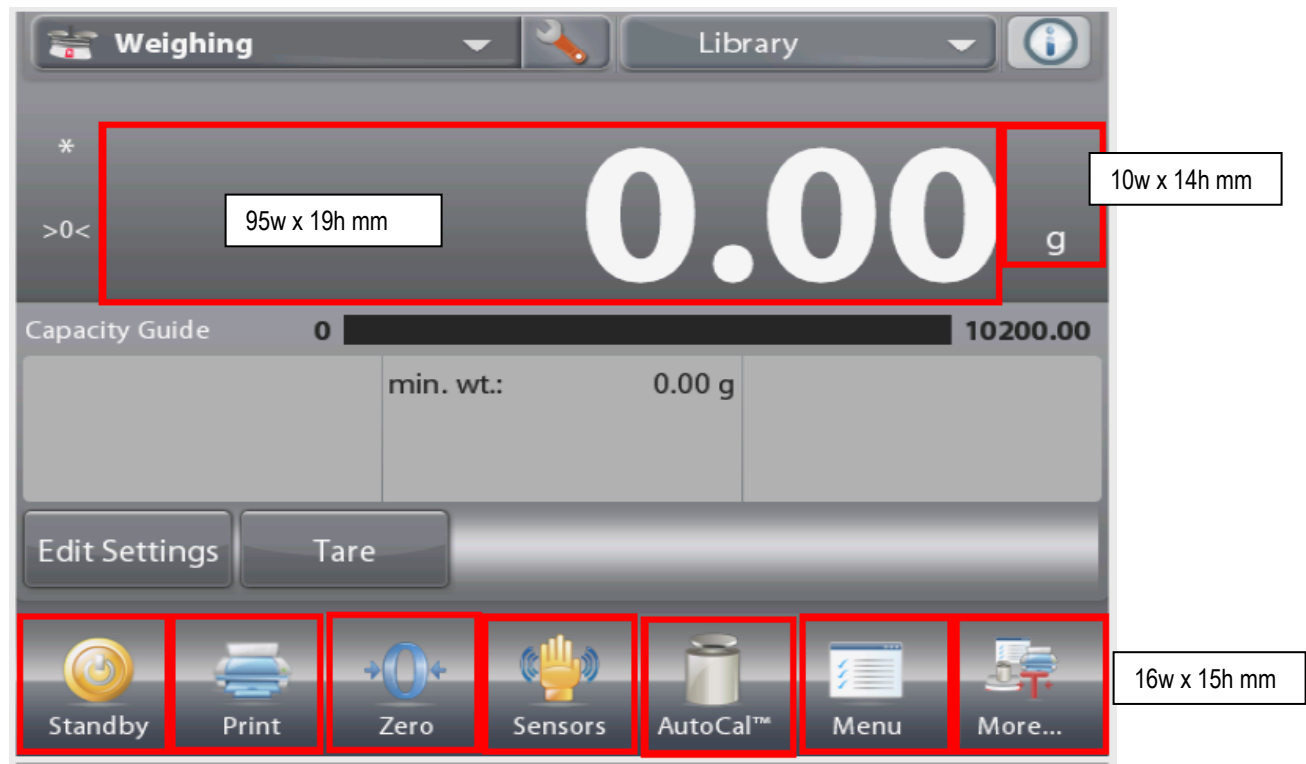

Application with Two lines:



Application with Two lines and Message:

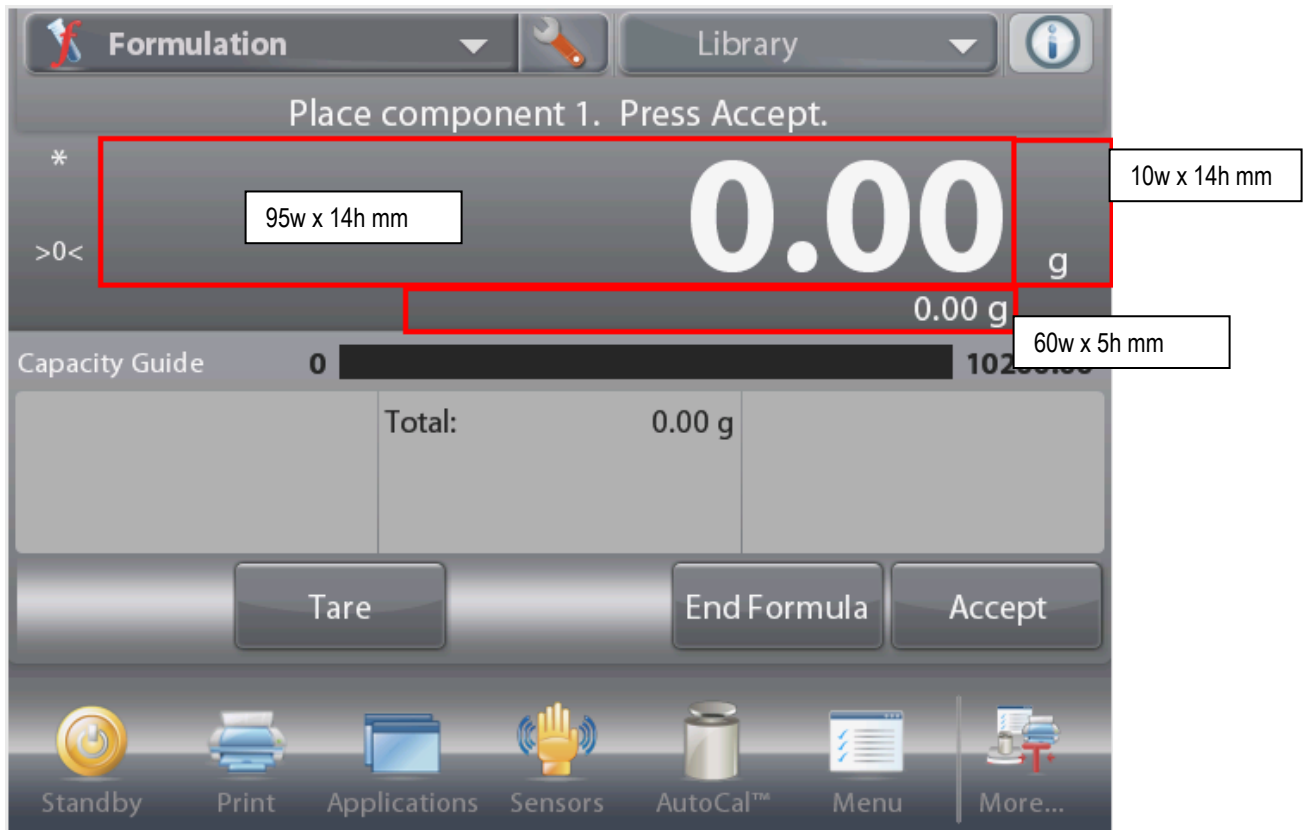

Note: If text area is grayed out, button cannot be selected.

## 2 DIAGNOSTIC GUIDE

This section of the manual contains troubleshooting information. Information is contained to isolate specific problems using Table 2-1, Diagnostic Guide. Follow all directions step by step. Make certain that the work area is clean. Handle balance components with care. Use appropriate electro-static protection devices to prevent damage to the sensitive electronic components.

### 2.1 TROUBLESHOOTING

General procedures for Troubleshooting:

1. Do the most obvious, user-level remedies.
2. Visual Check:
  - Check that the internal parts are clean and free from debris.
  - Examine the balance for damage or signs of abuse, replace any damaged items.
3. Use the error code table for solutions for specific codes.
4. Use the Diagnostic Guide; locate the symptom then follow the suggested remedies in order.



**Note:** Allow equipment to warm up for 60 minutes on precision models for optimal weighing performance. Allow 4 hours for analytical models to stabilize.

### 2.2 SOFTWARE

In most cases understanding the customer's problem with the balance is easy. Physical damage, displayed error code, failure to power up and obvious poor performance can usually be repaired by following the instructions in the following sections.

Some balance issues may be software related. New releases of the software may correct these issues. The Explorer® Balance has upgradeable software in the Terminal and the Base modules. The software revision in the balance can be seen when the balance is in standby mode or during the power up sequence. The software version is displayed in the lower right hand corner of the screen. The screen will show:

Model number	for example:	Explorer® EX6201
Capacity and readability		6209g x 0.1g
Software Revision "Terminal" / "Base"		Version 1.00 / 0.14

The balance software can also be retrieved by sending a "PV" command via the RS232 or other interface.

See **Appendix C** for the software upgrade procedure.

Check the Service Bulletins on the Ohaus DMX site for information on software upgrades.

### 2.3 DIAGNOSTIC GUIDE

Diagnostic Guide designed to help locate the problem area quickly and easily. The probable causes are listed with the most common cause first. If the first remedy does not fix the problem, proceed to the next remedy. Before attempting to repair the balance, read all chapters of this manual to be familiar with the balance components and operation.

Diagnosis:

1. Isolate and identify the symptom.
2. Refer to Diagnostic Guide tables and locate the symptom.
3. Follow the suggested remedies in the order they appear.
4. Perform the indicated checks, or see the appropriate section of the manual.
5. Repair or replace the defective section of the balance.

**NOTE:**

If more than one symptom is observed, approach one area at a time, and remember that the symptoms may be interrelated. If a problem arises that is not covered in this manual, contact Ohaus Corporation for further information.

**TABLE 2-1 DIAGNOSTIC GUIDE**

Symptom	Possible Cause	Remedy
Cannot turn on	Cannot exit Standby Mode, possible software lock-up.	Cycle the power off then on.
	No power to the Adapter	Verify input voltage to the Power Adapter.
	Bad Power Adapter	Verify the Power Adapter output voltage using a DVM.
	Input Jack or internal wiring is defective.	Verify 12VAC at the Power Jack wire connection to the PCB.
	Bad connection between terminal and base	Re-connect base and terminal
	Defective Base Main PCB	Replace base Main PCB, see Section 3.4.2
Touch Panel controls do not respond	Software lock-up	Cycle the power off then on.
	Touch Panel defective	Replace, see Section 3.6
	Bad touch panel calibration	Enter main menu to re-calibrate touch panel, see Appendix A.
	Defective Terminal Main PCB	Replace Terminal Main PCB, see Section 3.4.1
Incorrect weight reading	Improper calibration	Perform span calibration
	Poor linearity performance	Perform linearity calibration
	Unstable environment- vibration, air currents or changing temperature	Move balance to suitable location, allow balance to stabilize its temperature
	Internal mechanical interference	Verify the pan Support is not contacting the top housing
	Bad load cell	Replace load cell
Poor repeatability	Internal mechanical interference	Verify the pan Support is not contacting the top housing

## CHAPTER 2 - DIAGNOSTIC GUIDE

	Bad load cell	Replace load cell
Cannot calibrate	Calibration Menu locked	Unlock, see User manual
	LFT set to ON	Turn LFT off.
	Unstable environment- vibration, air currents or changing temperature	Move balance to suitable location, allow balance to stabilize its temperature
	External Calibration mode- incorrect calibration masses used	Use correct mass value as shown on the scale or enter the known mass value as instructed on the scale.
	Incorrect weight reading or poor repeatability	See Incorrect weight reading and Poor repeatability
Cannot change menu settings	Sub-menu locked	Unlock sub-menu
	LFT set to on	Turn LFT off
Cannot access a Mode	Desired Mode not enabled	Enter Main Menu then Application Modes to set the appropriate mode on.
Cannot access a Unit	Desired unit not enabled	Enter Main Menu then Weighing Units to set the appropriate unit on.
RS232, USB or Ethernet interface not working	Balance communications settings do not match with the settings in the connected computer.	See User Manual for proper settings
	Poor Cable connection	Check cable connection
	Defective Interface or cable	Replace
Low Reference weight	Reference weight is too small	Increase reference weight or continue with less accurate results.
Invalid Piece Weight	Parts counting– average piece weight is too small.	Shows error – returns to re-establish the APW.
Operation Timeout	Weight reading not stable	See above - Incorrect weight reading
	Busy (tare, zero, printing)	Retry after completion
Pressing “Print” or command “P” do not work immediately	RS232, USB or Ethernet interface not working	see above – RS232, USB or Ethernet interface not working
	Print settings enable the stable print, but there is unstable environment- vibration, air currents or changing temperature	Move balance to suitable location, allow balance to stabilize its temperature; <b>or</b> set “Main Menu -> Communication -> RS232/USB/Ethernet -> Print Settings -> Print Output -> Stable Weight Only” to OFF
Overload	Weight on pan exceeds capacity	Remove weight from pan
Underload	Pan is removed during weighing	Re-install pan
Over initial zero range	Pan has load during power on	Remove weight from pan and re-zero.
Under initial zero range	Pan was removed prior to power on	Install pan and re-zero.



IDNR error	Type data error	Contact the authorized dealer
--operation not allowed--	There is no sample on the pan when doing Tare	Place sample on the pan and redo Tare
Shortcut buttons are gray and no action when pressing them.	The current application is in procedure.	Cancel the procedure first.
Does not retain the correct time and date.	Battery backup for the real time clock has lost its charge.	Replace the real time clock battery on the Base Main PCBA, see 3.4.2

**Note:** There is 40-second timeout control for print under stable requirement. If the unstable condition continues over 40 seconds, balance will send “ES” to the printer.

### 3 MAINTENANCE / REPAIR PROCEDURES

#### 3.1 PREVENTIVE MAINTENANCE

Ohaus balances are precision instruments and should be carefully handled, stored in a clean, dry, dust-free area, and cleaned periodically. Follow these precautionary steps:

- When a balance has had chemicals or liquids spilled on it, all exterior surfaces should be cleaned as soon as possible with warm water on a damp cloth.
- Do not leave a mass on the balance when the balance is not in use.
- Allow time for the balance to stabilize after moving it from an area which is at a different temperature than the area where it is to be operated. Allow one hour for each 5°F (2.7°C) temperature change before using the balance. After temperature stabilization, allow an additional 60 minutes after turning the balance on, for the balance electronics to stabilize.

#### **Preventive Maintenance Checklist**

The balance should be inspected and checked regularly, as follows:

1. Remove the Pan and Sub Pan to inspect and clean the area beneath the Pan.
2. Clean the outside of the balance using a damp cloth with warm water.
3. Check the Power Cord for broken or damaged insulation.
4. Make a visual inspection for faulty connectors, wiring, and loose hardware.



#### **CAUTION**

DO NOT USE CHEMICAL CLEANERS OR SOLVENTS OF ANY TYPE.  
SOME CLEANERS ARE ABRASIVE AND MAY AFFECT THE BALANCE'S FINISH.

#### 3.2 OPENING THE BALANCE

Opening the Explorer® balance varies slightly according to the specific model, as detailed below. Use these procedures in order to replace the Load Cell, the Printed Circuit Board or other components.

Common hand tools are sufficient to disassemble the Explorer® balances.

##### **3.2.1 Preparation for Opening Explorer® Models**

1. Turn the balance off and unplug the power cord before you begin.
2. Disconnect any communication or other option cables.

3. Draftshield models – remove the Top and Side Doors and the Front Panel



4. Remove the Platform, Sub-Platform, Support Caps and Wind Ring as required.



EX12001, EX24001, EX35001

5. Detach and disconnect the Indicator module.

To detach, press both the Release buttons inward (both at the same time) and gently pull the Terminal towards you (outward) until the Terminal is detached. Disconnect the Terminal Cable.



**3.2.2 Opening the Terminal Module**

1. Remove the Terminal Bracket from the Terminal Module. Press the two Angular Adjust Buttons to allow the Terminal Bracket to swing free. Flex the bracket at its center to release one hinge pivot at a time.

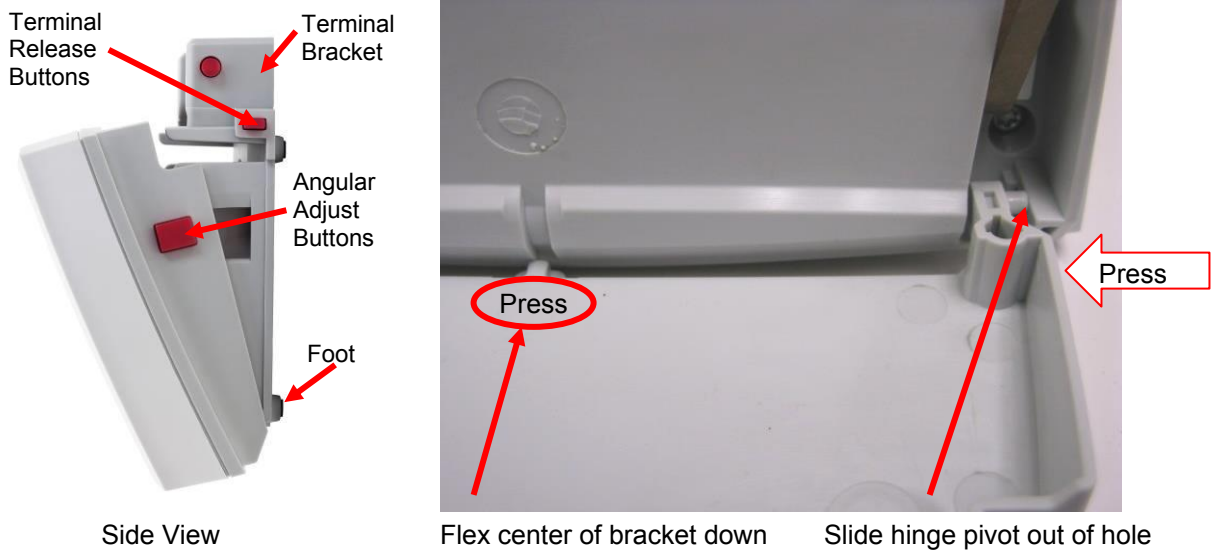

2. Remove the 4 screws securing the Terminal Top and Bottom Housings.

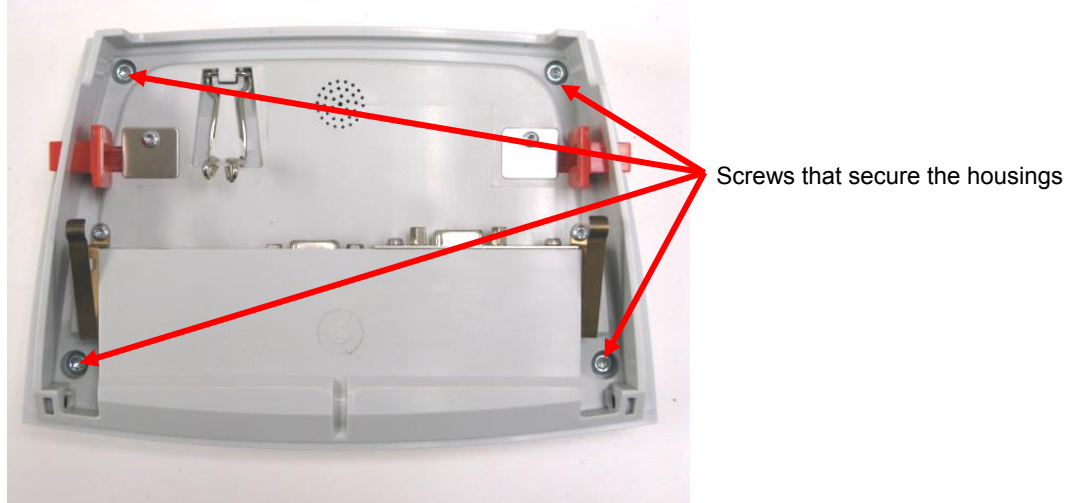

3. Turn the module over and open the upper housing. Be careful not to pull on the cables.

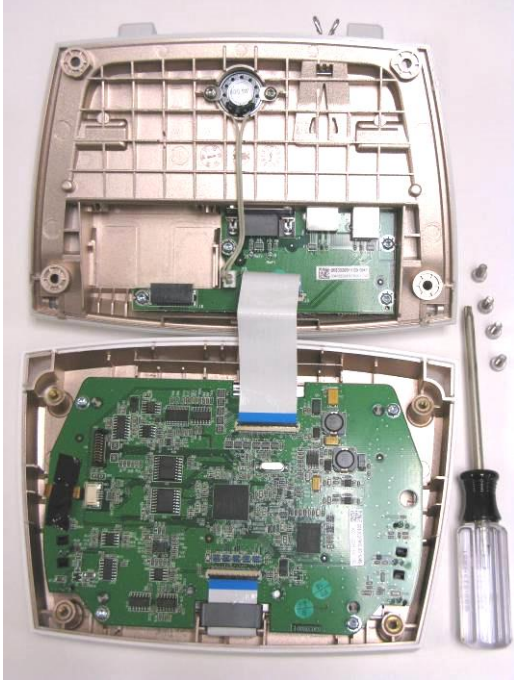

4. Disconnect the ribbon cable connecting the two assemblies. Using a finger nail or a thin screw driver blade rotate the black cable-lock on the connector 90° so that it is perpendicular to the cable.

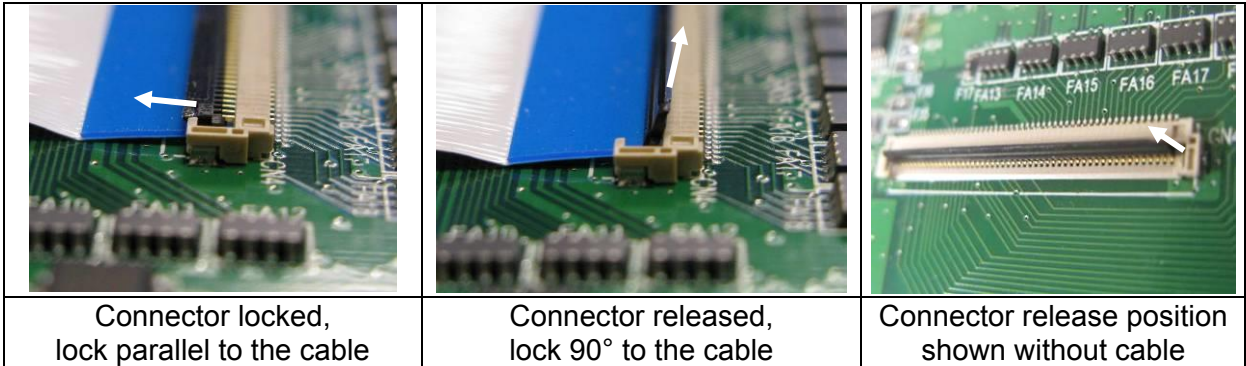

**3.2.3 Opening the Base Module with a Draftshield**

1. Prepare the balance as instructed above.
2. Remove the EMC Screw and Plate from the Base



3. Remove the Back Plate

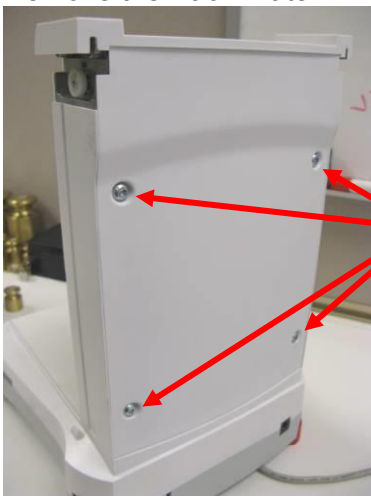

Screws that secure the Back Plate

4. Disconnect the Light Cable.

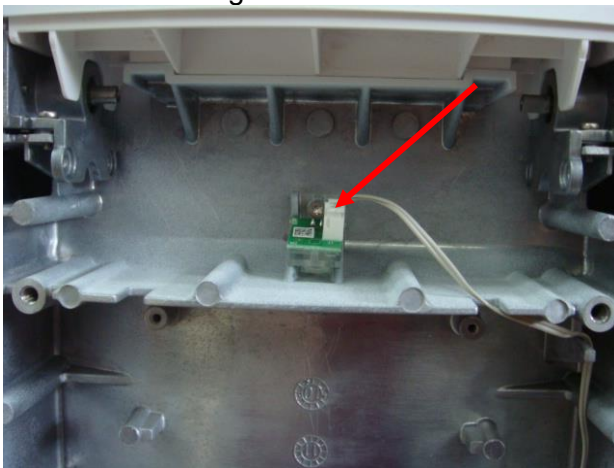

5. Remove the two Rear Support screws.



6. Remove the Rear Support being careful to route the Light and Motor Cable through the holes in the Support.
7. Turn the base over and remove the two remaining screws that hold the Top Housing to the Base.

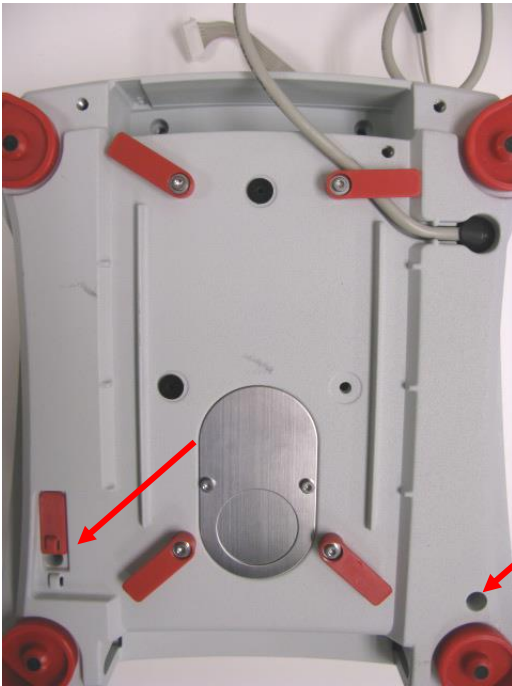

8. Turn the Module over. Remove the Top Housing being careful to route the Light Cable and Motor Cables (if equipped) through the holes in the Upper Housing.

## CHAPTER 3 - MAINTENANCE / REPAIR PROCEDURES

9. Disconnect the Bubble Light Cable from the Connect PCBA. The Top Housing can now be separated.



### 3.2.4 Opening the Base Module (Top Loader)

1. Prepare the balance as instructed above.
2. Turn the base on its side and remove the 4 screws that hold the Top Housing to the Base. Do not turn the Base completely over as the weight of the Base will rest on the Load-cell possibly causing damage.





3. Turn the base back on its feet and remove the Top Housing. Lay the Top Housing alongside so that the Bubble Level Light wiring can be disconnected.

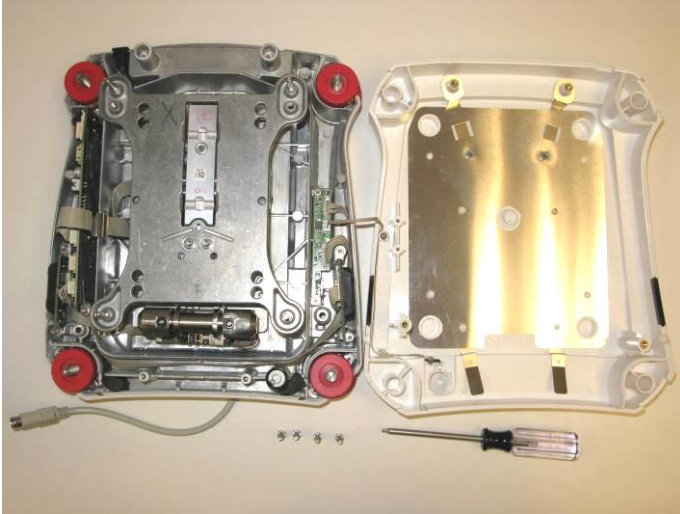

4. Disconnect the Bubble Level Light wiring by pulling up on the connector.

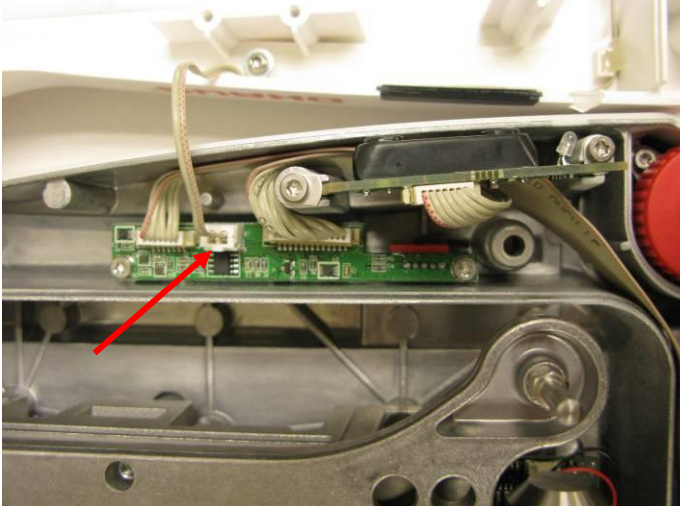

## CHAPTER 3 - MAINTENANCE / REPAIR PROCEDURES

---

### 3.2.5 Opening the Base Module (EX12001, EX24001, EX35001)

1. Prepare the balance as instructed above.
2. Remove the 2 screws that hold the Spider to the Top Housing and lift off the Spider.



3. Remove the 7 screws that hold the Top Housing to the Base.

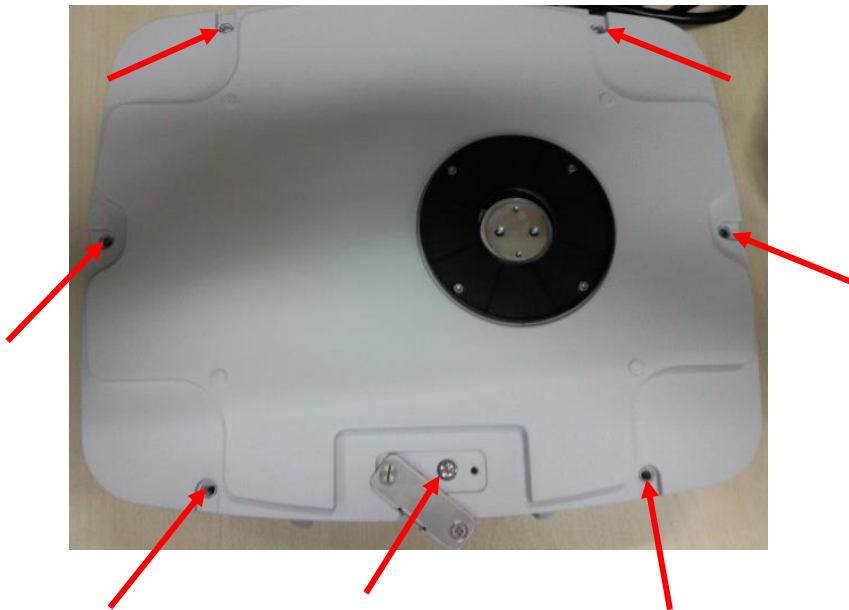

4. Remove the Top Housing

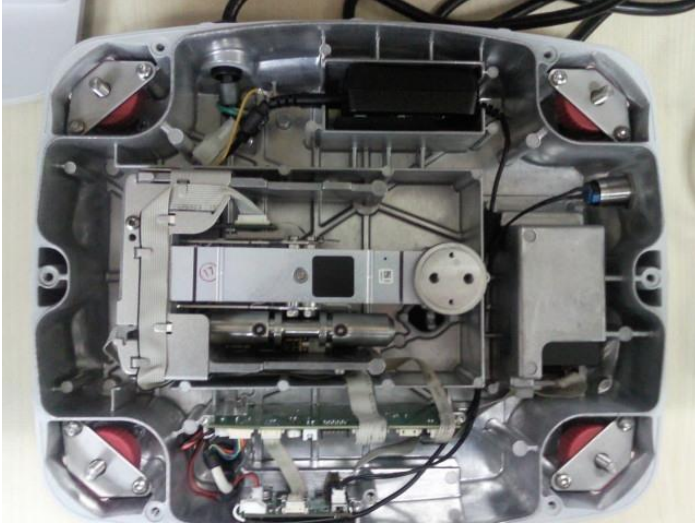

### 3.3 REPLACING THE LOAD CELL (not 12001, 24001 and 35001)

The Load Cell may need to be replaced because of balance instability, or because the balance does not calibrate or repeat, or because it is physically broken or displays an error code.

For replacing the load cell on EX12001, EX24001 and EX35001 please see section 3.4.

Note: Explorer® Load Cells are not serviceable in the field due the special tools and test conditions required to ensure that it is working properly. No spare parts are available for the Load Cell Module.

#### Disassembly:

1. Open the balance – see Section 3.2. Verify that there is no mechanical interference, pinched wire or bad solder connection that may be causing the load cell to appear defective.
2. Remove the Load-cell Shield by lifting vertically. Note the Top Loader models do not have a Load-cell Shield.



3. Disconnect the two Load Cell connections at the Main PCB.

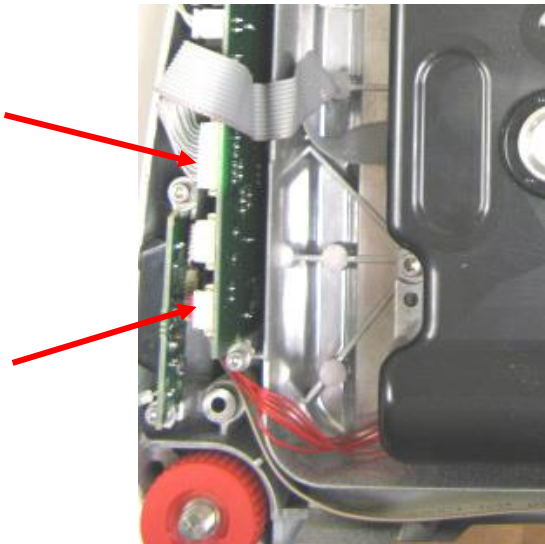

- 4. Remove the Load Cell –remove the 4 load cell screws from the bottom housing. Lift the Load Cell Module from the Base. Do not lift by the Pan Support Cone or the cables.

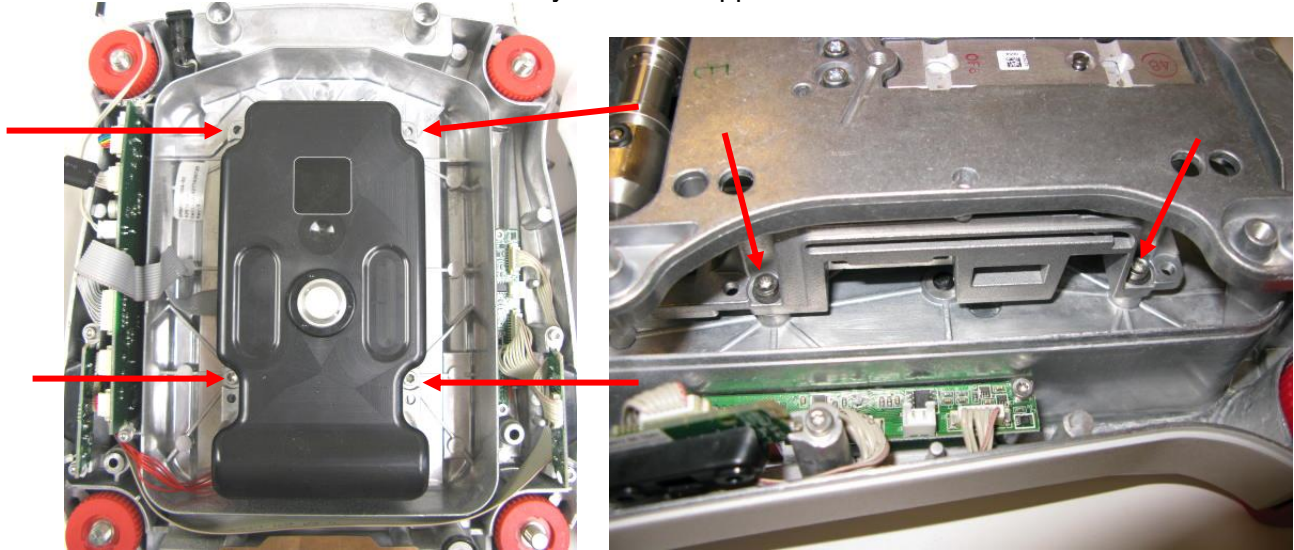

**Re-Assembly:**

Reverse the disassembly procedure to assemble the balance. Ensure that there is no foreign material between the Base mounting surfaces and the Load cell.

Take special care to route the wires and cables as shown in the following pictures. Proper routing is important for RFI/ESD performance. Ensure that the wires or cables are not pinched during re-assembly.

InCal cable routing – Draftshield models:

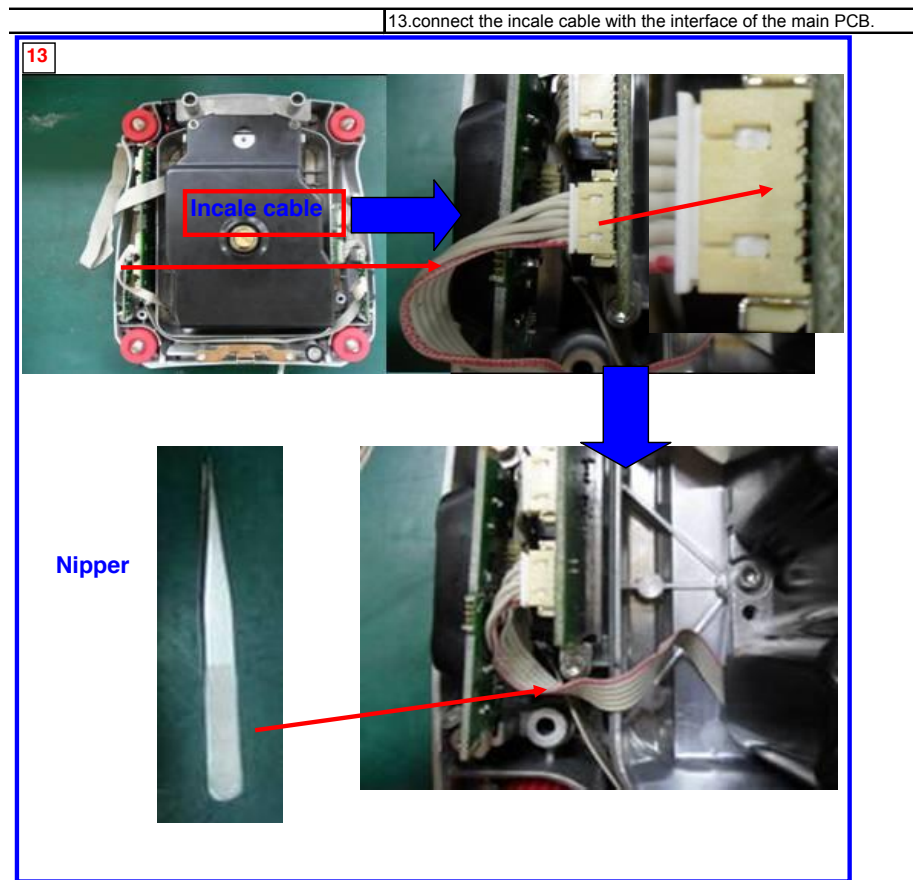

Load-cell cable routing – Draftshield models:

10. fold the cable beside the main PCB at the third time at the length of at about 3 centimeter, and bend about 1cm at the fourth time.

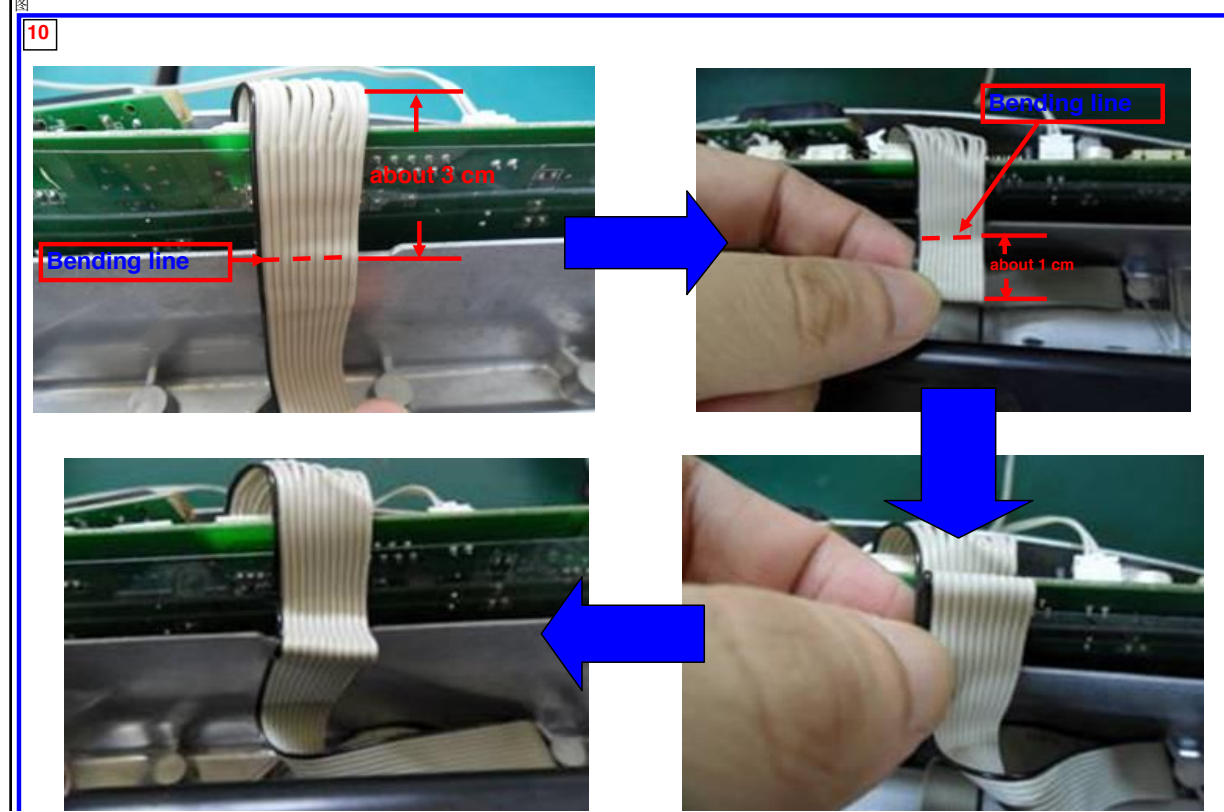

11. Insert the bended loadcell cable into the space between film and bottom.

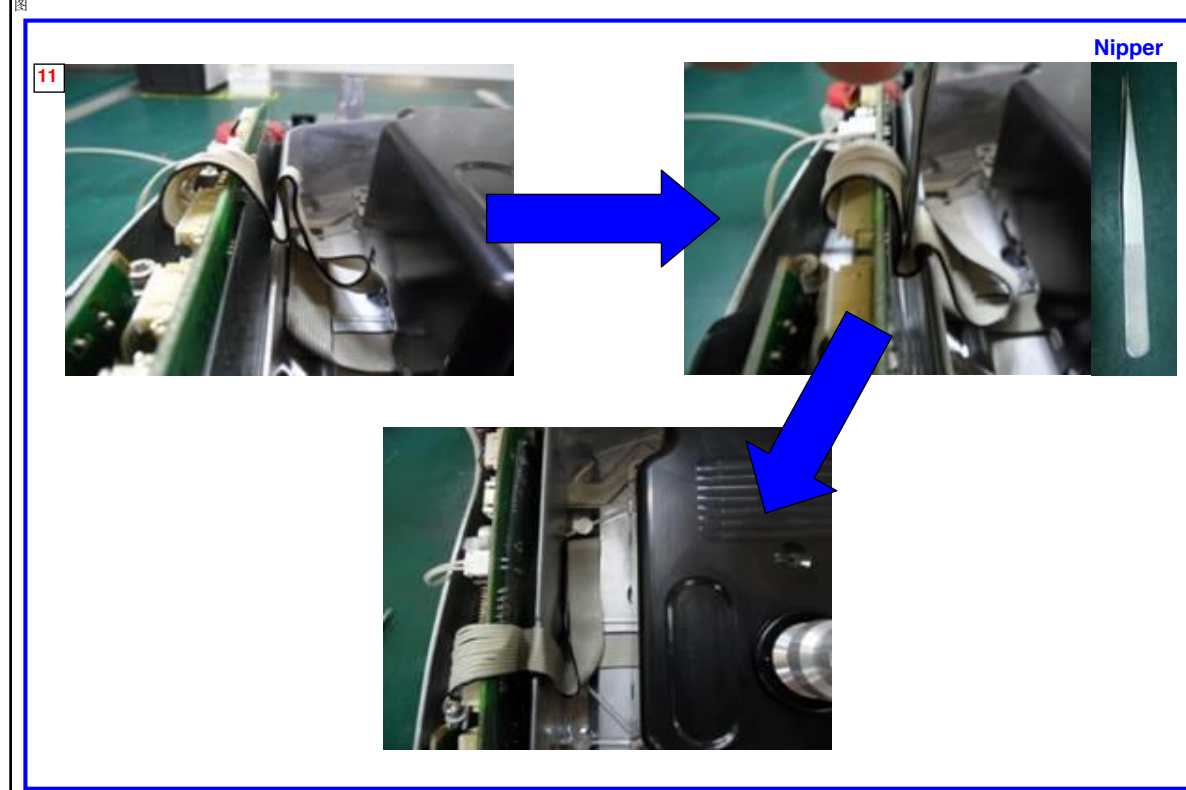

InCal cable routing – Non-Draftshield models:

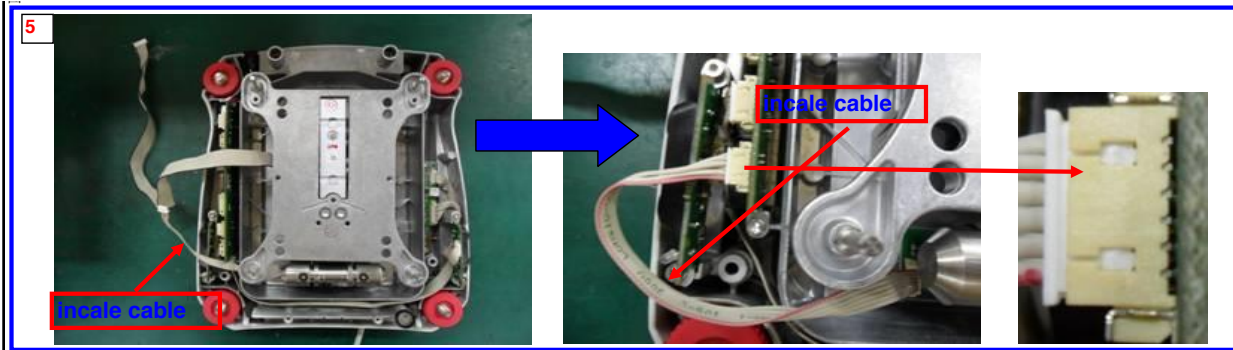

7. Put the cable into the slot using nipper and make sure the cable not cover the screw hole

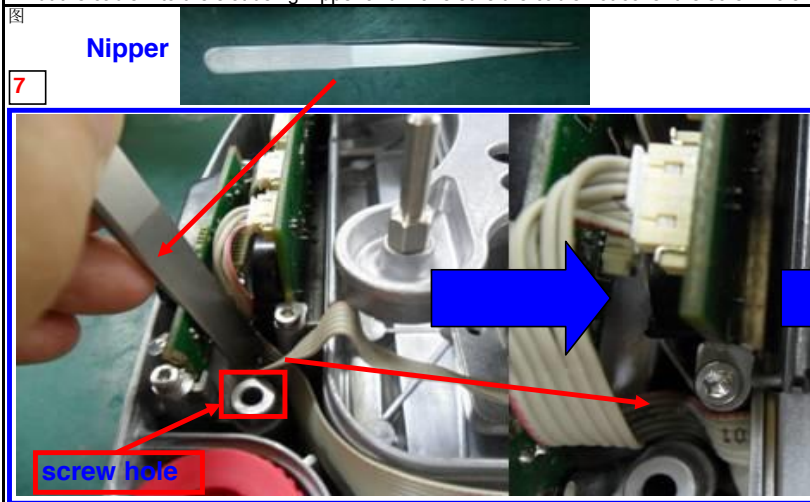

## CHAPTER 3 - MAINTENANCE / REPAIR PROCEDURES

Load-cell cable routing – Non-Draftshield models:

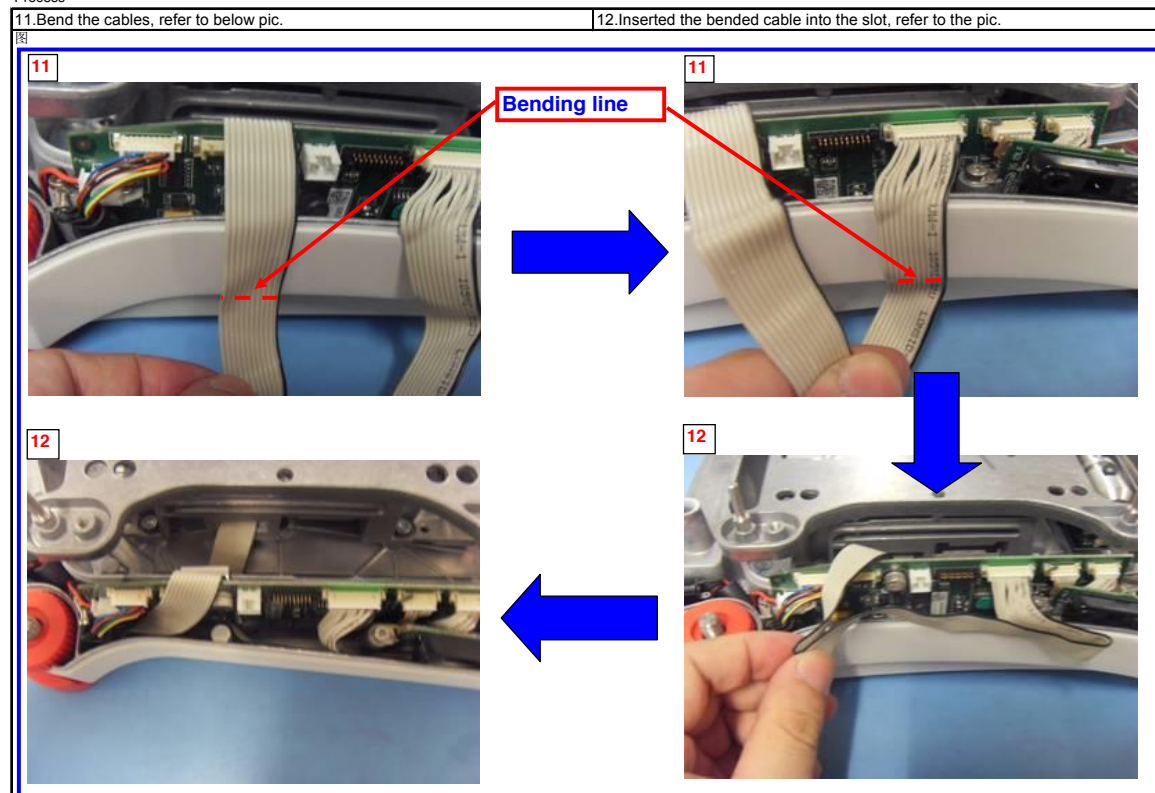
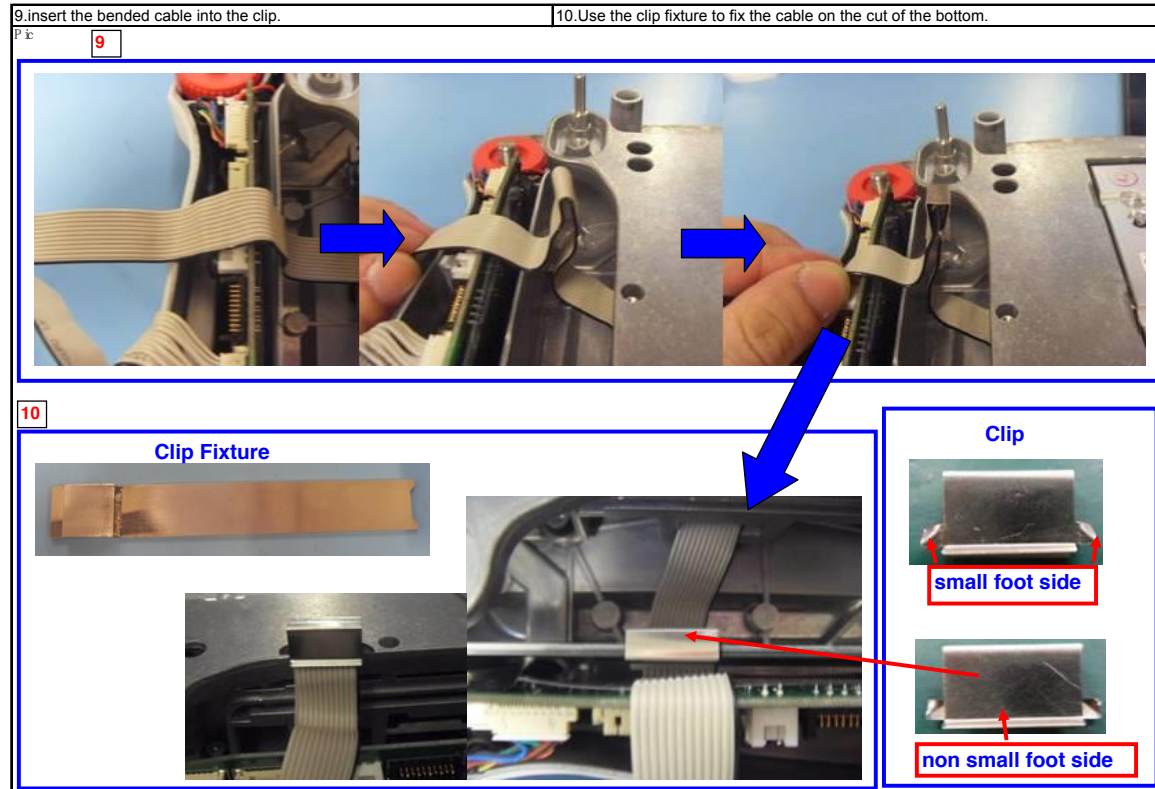

See **Appendix C** for instructions on how to use the software Service Tool to configure the new load-cell to the balance.



### 3.4 REPLACING THE LOAD CELL (12001, 24001 and 35001)

The Load Cell may need to be replaced because of balance instability, or because the balance does not calibrate or repeat, or because it is physically broken or displays an error code.

Note: Explorer® Load Cells are not serviceable in the field due the special tools and test conditions required to ensure that it is working properly. No spare parts are available for the Load Cell Module.

#### Disassembly:

1. Open the balance – see Section 3.2. Verify that there is no mechanical interference, pinched wire or bad solder connection that may be causing the load cell to appear defective.
2. Turn the base on its side and remove the 3 screws that hold the Load Cell to the Base. Do not turn the Base completely over as the weight of the Base will rest on the Load-cell possibly causing damage.

Note: Make sure to hold on to the load cell with one hand when unscrewing the last screw to prevent it from falling out.



3. Turn the base back on its feet making sure that the load cell do not fall out.

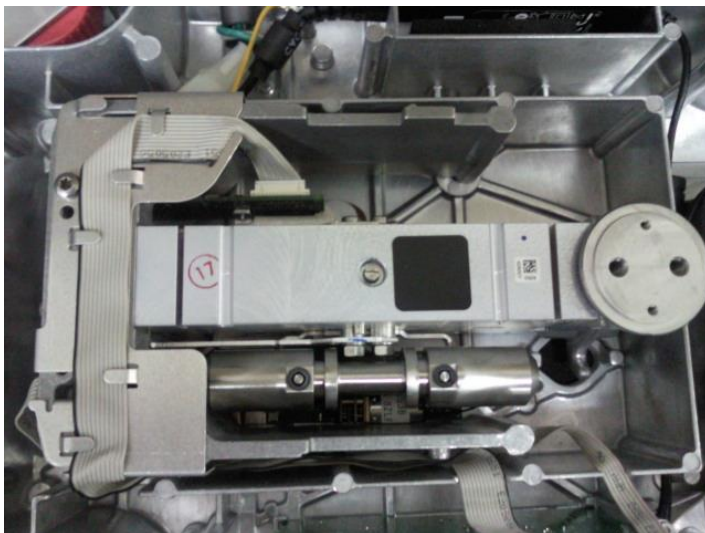

4. Remove all cables connecting the load cell to the PCB and lift the load cell out from the housing.

### Re-Assembly:

Reverse the disassembly procedure to assemble the balance. Ensure that there is no foreign material between the Base mounting surfaces and the Load cell.

Take special care to route the wires and cables according to their original positions. Proper routing is important for RFI/ESD performance. Ensure that the wires or cables are not pinched during re-assembly.

### 3.5 REMOVING LOAD CELL PROTECTION SCREWS

**Attention:** This process is only needed for 1, 2 and 3 decimal scales.

It is very important to remove the shipping protection screws after assembling the load cell into the scale housing; otherwise the load cell will not work. Please follow the steps below.

1. Place the load cell in front of you, as shown in the picture below.

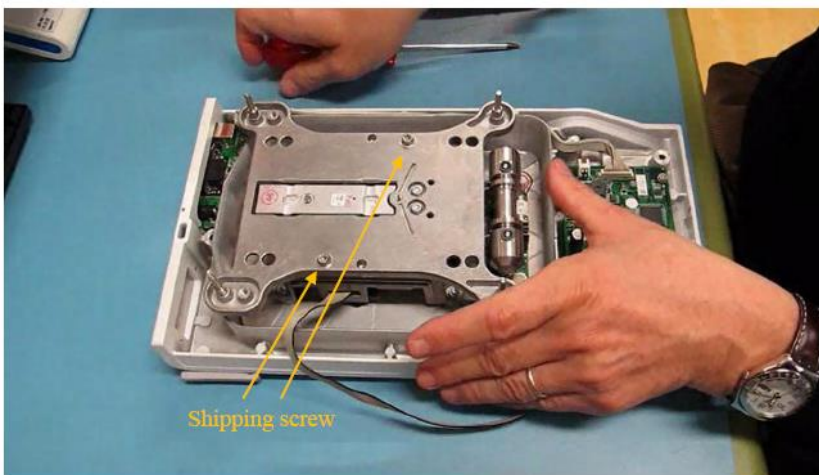

2. Start by removing the screw on your left side. Please pay attention to not shift the spider from its position during this procedure. Follow by removing the screw on the right side.
3. Remove both screws with shims completely from the load cell. Please store the screws and shims in a safe place.

### 3.6 REPLACING THE PRINTED CIRCUIT BOARD ASSEMBLIES (PCBA)

Before working with the exposed PCBAs appropriate ESD protection must be taken to prevent damage to the sensitive electronic components. It is recommended that a conductive mat with wrist straps be used when working with electronic components.

#### 3.2.5 Terminal

1. Open the Terminal Module – see Section 3.2.
2. Remove the accessory module, if equipped.
  - Remove the 2 retaining screws in the mounting plate.
  - Slide out the module

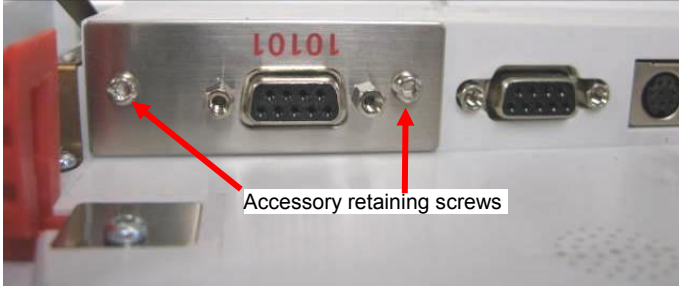

3. Remove the **Interconnect PCBA** – Disconnect the speaker connector from the Connector PCB, remove the 4 mounting screws and slide the PCBA forward and up to remove.

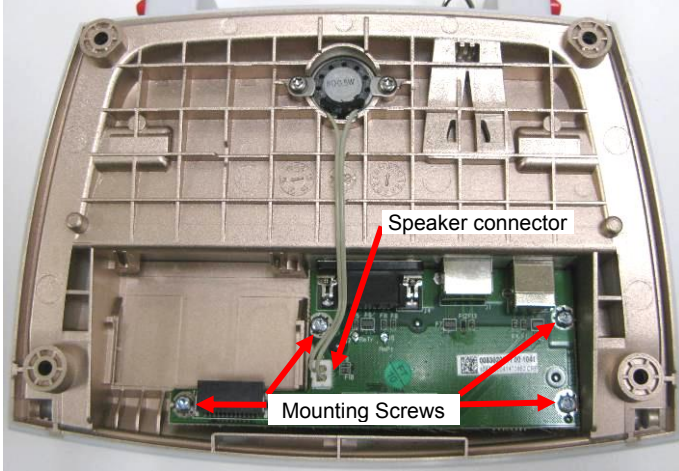

4. To remove the speaker remove the 2 screws and lift out.

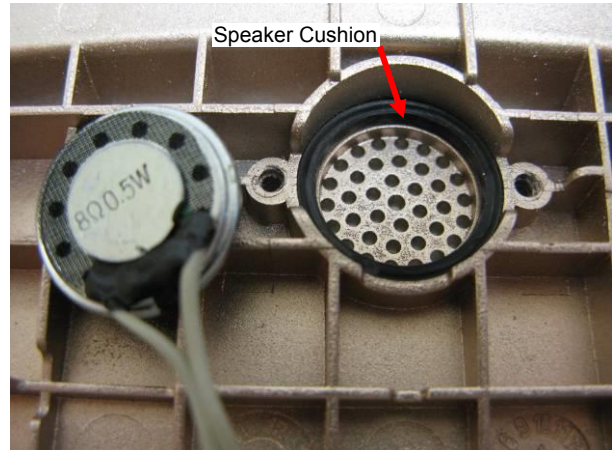
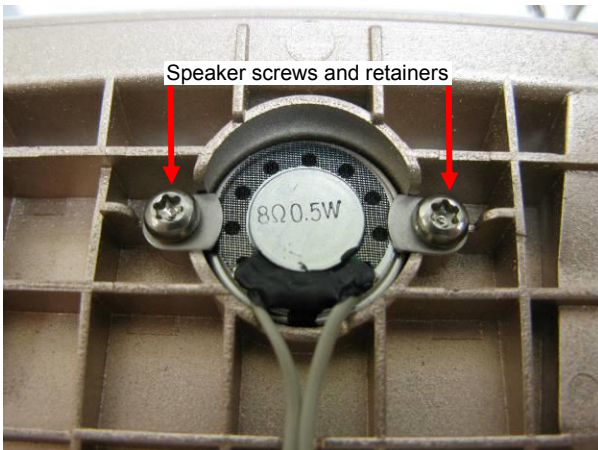

## CHAPTER 3 - MAINTENANCE / REPAIR PROCEDURES

### 5. Remove the **Main PCBA**

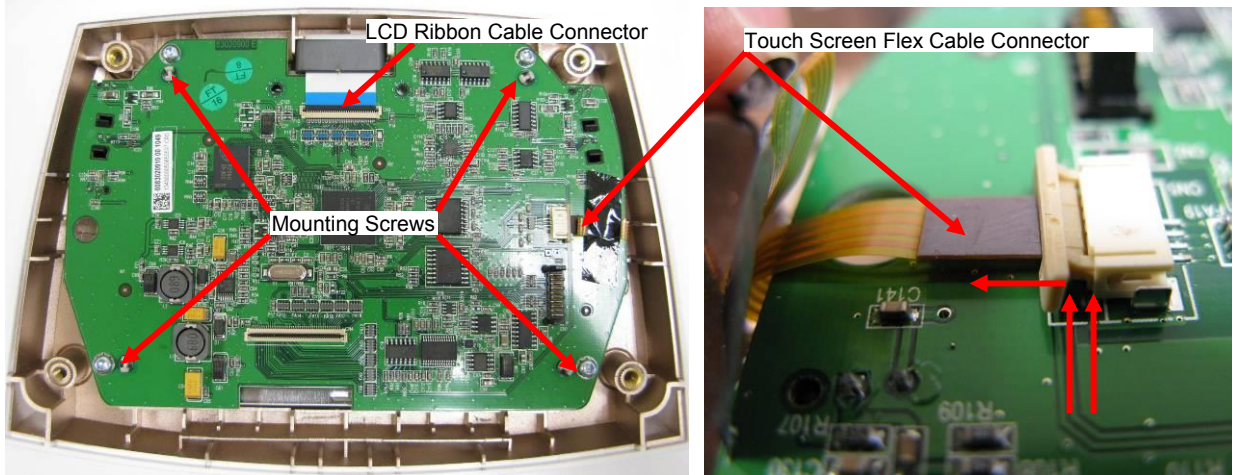

- Unlock the LCD ribbon cable connector (see “Opening the Terminal Module” above). Removing the cable.
- Disconnect the Touch Panel flex cable by sliding the black release. Remove the cable from the connector.
- Remove the 4 mounting screws and lift out the Terminal Main PCBA.

### 6. Remove the **LC Display** by simply lifting it out.

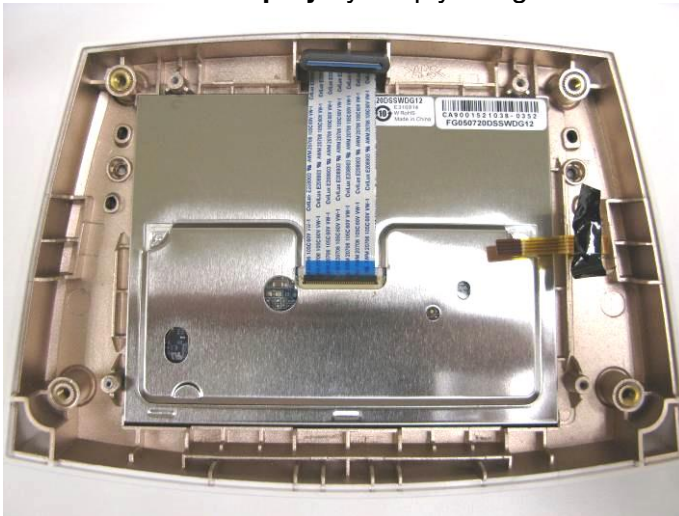

### 7. See Section 3.6 for instructions on changing the **Touch Panel**.

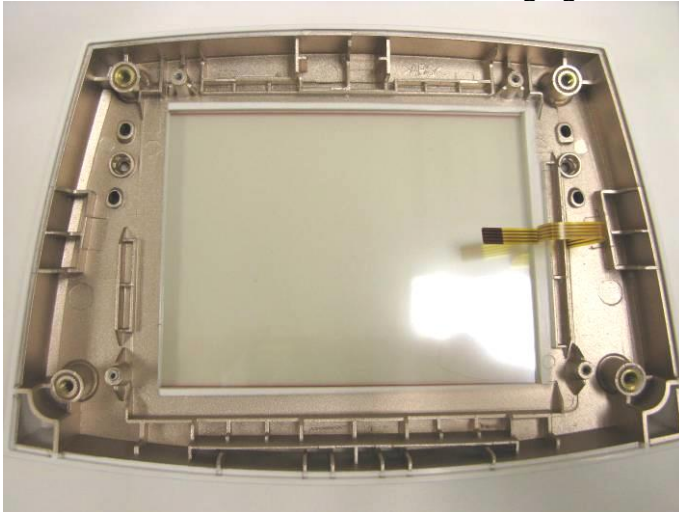

### 3.2.6 Base

1. Open the Base Module – see Section 3.2.

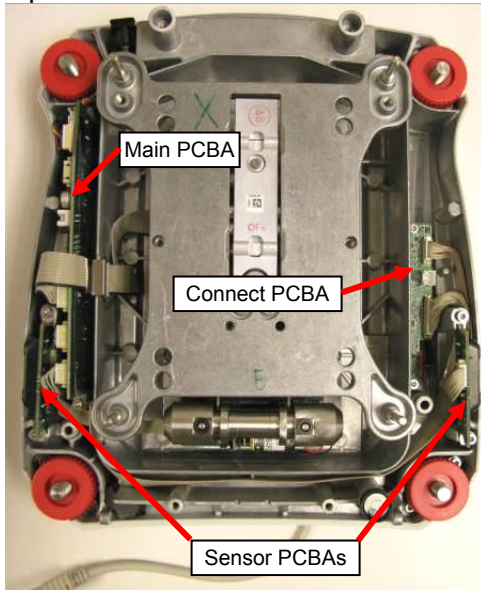

2. Remove **IR Sensor PCBAs**

The left and right PCBAs are identical. The PCB is symmetrical about its length so that the Indicator LED is able to be mounted forwards on both sides. The cable connector will face up or down depending on the side it is mounted.

- Loosen the 2 retaining screws approximately 2 turns
- Rotate the retaining washers so that it no longer engages the PCB, slide out the PCBA
- Disconnect the cable at the Connect PCBA.



## CHAPTER 3 - MAINTENANCE / REPAIR PROCEDURES

### 3. Remove the **Connect PCBA**

- Disconnect the Connect Cable to the Main PCBA.
- Remove the 2 retaining screws, the PCB is now free
- During disassembly and re-assembly note how the switch engages the Switch Actuator.

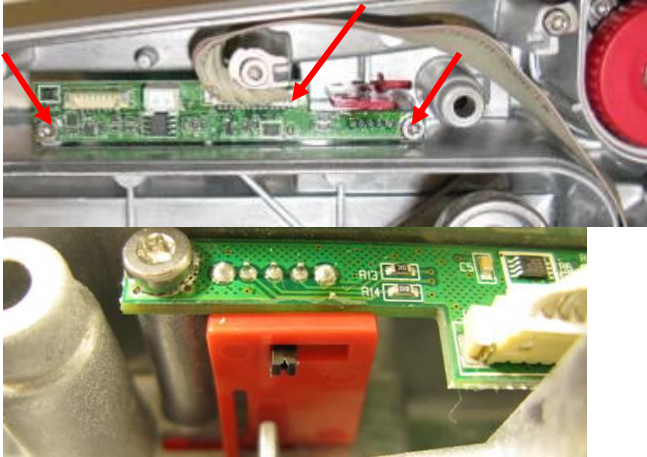

### 4. Remove **Main PCB**

**Note:** For EX12001, EX24001 and EX35001 models please see section 5.

- Remove the left IR Sensor PCBA (see above).
- Disconnect the cables along the top edge of the PCB.

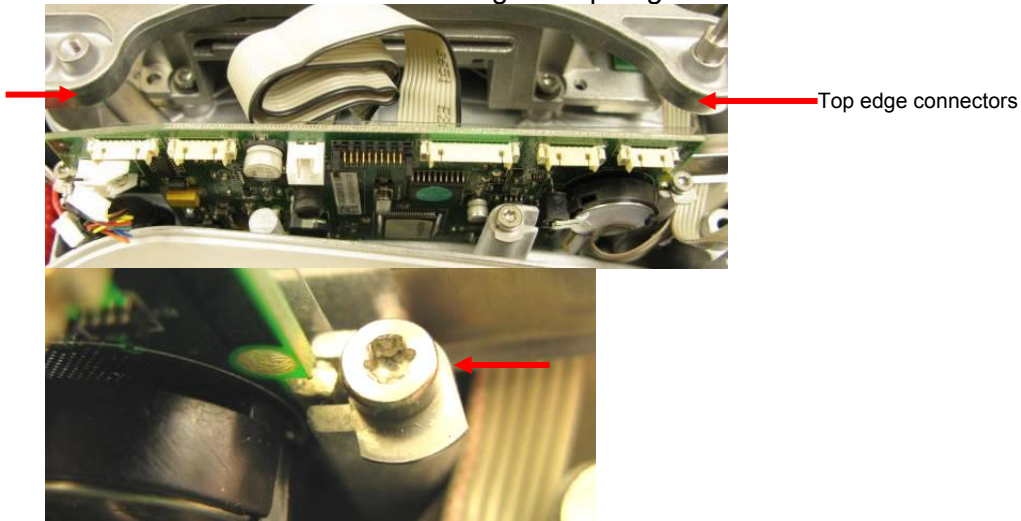

- Loosen the 2 retaining screws approximately 2 turns
- Rotate the retaining washers so that it no longer engages the PCB, slide out the PCB
- Disconnect the Power Jack and the Ribbon Cable to the Connector PCBA cables

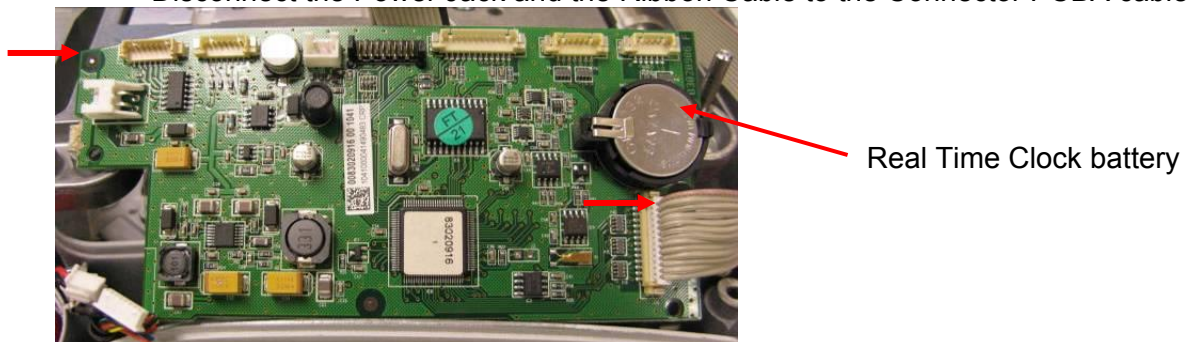

**Re-install:**

Reverse the procedures to re-install the PCBAs. See **Appendix C** for instructions on how to use the software Service Tool to configure the new PCBA to the balance.

5. Remove **Main PCB (EX12001, EX24001, EX35001)**

- Disconnect the cables along the top edge of the PCB.

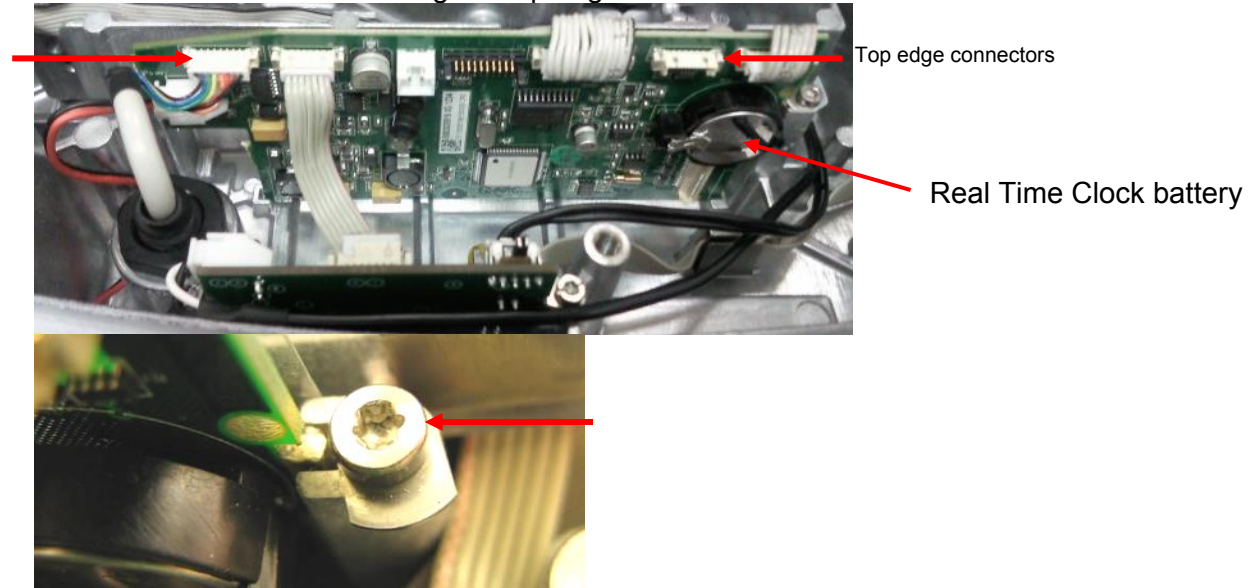

- Loosen the 2 retaining screws on each side of the PCB with approximately 2 turns
- Rotate the retaining washers so that it no longer engages the PCB, slide out the PCB

**Re-install:**

Reverse the procedures to re-install the PCBAs. See **Appendix C** for instructions on how to use the software Service Tool to configure the new PCBA to the balance.

### 3.7 Replacing the Function Label

If only the Function Label is damaged the Touch Panel does not need to be replaced (See Chapter 5 for parts information.)

- **Remove the old label:**  
Working from a corner, use a broad blade, such as a wide X-Acto™ knife, to remove the label. Be careful not to cut into the plastic Housing (or into yourself). Work slowly allowing the adhesive time to release as it is separated from the plastic. Eye Protection should always be used when using a knife.
- **Clean the glue residue from the Housing surface:**  
Try using a section of the adhesive on the removed label to “pickup” as much of the remaining adhesive on the housing as possible. Using the knife or your fingers try to “roll” up the remaining adhesive. If the adhesive smears use a cotton cloth to pick up as much as possible. As a last resort a solvent such as Nail Polish Remover can be tried. First test the plastic on the inside of the Housing to see if the solvent damages the plastic. The solvent must not come in contact with the Touch Panel.
- **Install the new Function Label:**  
Trial fit the new label to become familiar with its placement. Remove the clear protective liner on the inside label window, verify that the window area is clean. Peel back about 1/3 of the liner material and cut it off (do not tear as the torn edge may expose untreated areas that will stick to the adhesive.). Align the label where the liner is still attached when satisfied press the area where the adhesive is exposed except for near the cut liner. Peel off the remaining liner and press the surface starting at the attached area and working outward to avoid bubbles under the label.



### 3.8 Replacing the Touch Panel

If the touch panel needs to be replaced, the whole Terminal top housing needs to be replaced. The Function Label also needs to be removed when the terminal top housing is replaced. The Function Label cannot be reused.

- Remove the Terminal Main PCBA and the LC Display (see above).
- Remove the Function Label (see above).
- Remove the Terminal top housing.
- Install a new Function Label (see above).
- Calibrate the Touch Panel. See **Appendix A** or the User Manual for the procedure to calibrate the Touch Panel.

### 3.9 Replacing the Feet

The feet assemblies incorporate a bearing assembly that allows for easy adjustment of the feet. There is a load bearing plate that transmits the load to the Base. The plate is not symmetrical so its placement is different in the front and rear locations (see sketch below). One edge of the plate has a slight curve. This curve should face inward and be towards the front of the balance in all locations.

The bearing assembly is made of three parts, two disks with a bearing ring in the center. The curved surface of the disks should face the ball bearings. Assemble the foot components in the order shown in the sketch below.

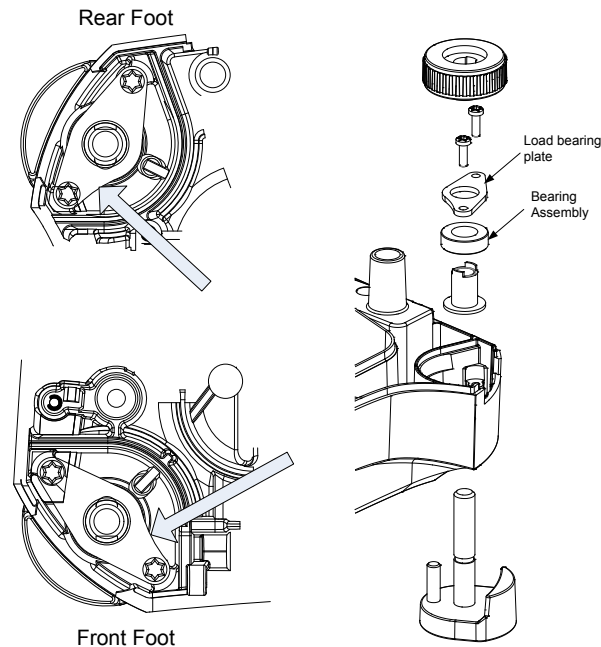

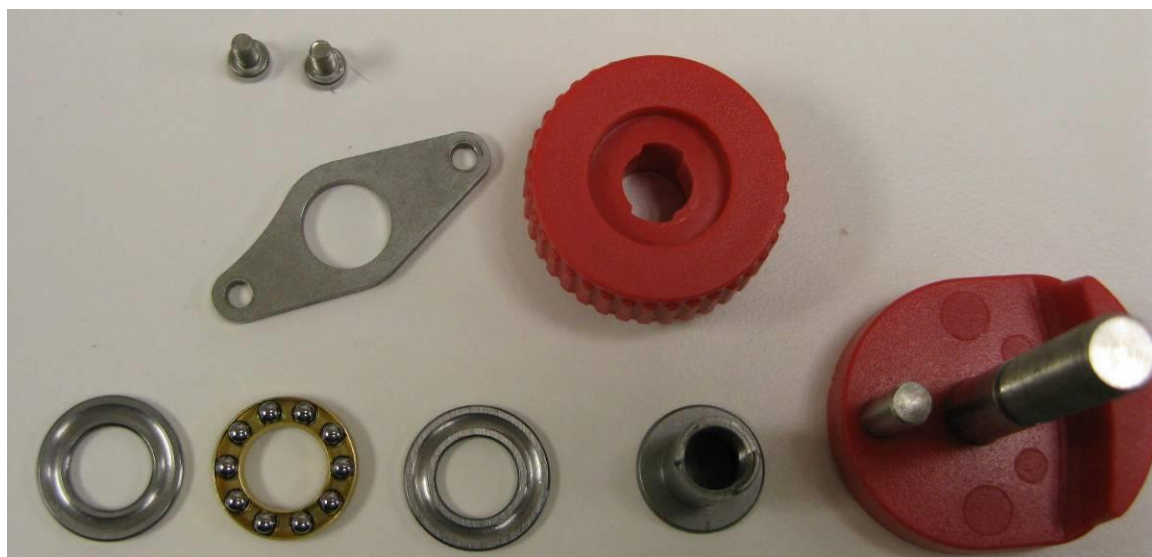

### **3.10 Replacing the Motor and Motor PCBA**

The feet assemblies incorporate a bearing assembly that allows for easy adjustment of the feet.

## 4 TESTING

Before and after servicing an Explorer<sup>®</sup> balance, an operational test and various performance tests should be made to confirm if the balance meets specifications. Turn the balance on and allow it to warm up for at least one hour before performing these tests. The Analytical models need up to 4 hours to stabilize.



### NOTE:

Make sure the test area is free from drafts and that the balance rests on a level and vibration-free surface. The Analytical models especially need a solid platform, such as a stone table.

### 4.1 TEST MASSES REQUIRED

The masses required to test the Ohaus Explorer<sup>®</sup> balances must meet the requirements of the ASTM or OIML Tolerances listed in the table. Poor quality calibration masses be the can cause of frustrating diagnostics.

**TABLE 4-1 CALIBRATION MASS VALUES**

Model	Span Calibration Points	Weight Class	
EX124	50g, <b>100g</b>	ASTM Class 1	OIML E2
EX224	100g, 150g, <b>200g</b>	ASTM Class 1	OIML E2
EX324, M, N	150g, 200g, <b>300g</b>	ASTM Class 1	OIML E2
EX223	100g, 150g, <b>200g</b>	ASTM Class 1	OIML E2
EX423	200g, 300g, <b>400g</b>	ASTM Class 1	OIML E2
EX623	300g, 400g, <b>500g</b> , 600g	ASTM Class 1	OIML E2
EX1103, M, N	500g, <b>1000g</b>	ASTM Class 1	OIML E2
EX2202	1000g, <b>2000g</b>	ASTM Class 1	OIML E2
EX4202	2000g, 3000g, <b>4000g</b>	ASTM Class 1	OIML E2
EX6202	3000g, 4000g, <b>5000g</b> , 6000g	ASTM Class 1	OIML E2
EX10202, M, N	5000g, <b>10,000g</b>	ASTM Class 1	OIML E2
EX6201	3000g, 4000g, <b>5000g</b> , 6000g	ASTM Class 2	OIML F1
EX10201	5000g, <b>10,000g</b>	ASTM Class 1	OIML E2
EX12001	3000g, 5000g, 10000g, <b>12000g</b>	ASTM Class 2	OIML F1
EX24001	10000g, 15000g, 20000g, <b>24000g</b>	ASTM Class 1	OIML F1
EX35001	10000g, 20000g, 30000g, <b>35000g</b>	ASTM Class 1	OIML F1

**Note:** Factory default settings are shown in bold. The calibration setting can be changed to allow the other choices.

### 4.2 OPERATIONAL TEST

1. Connect a functioning Power Adapter to the balance.
2. Plug the Power Cord into a suitable power source.
3. Verify that the balance start up sequence occurs properly. Note any error codes.

### 4.3 LOAD CELL TEST USING RAMP

To test the Load Cell using RAMP, see **Appendix B**.

### 4.4 PERFORMANCE TESTS

Accurate performance of the Explorer® balances is determined by a series of four performance tests. The displayed readings are compared with the tolerances listed in Tables 1-1. Tolerance values are expressed in counts. A one-count difference is shown in the last digit on the balance display.

The following performance tests are used to evaluate balance operation before and after repairs. The balance must meet the requirements specified in each test as well as the specifications listed in Table 1-1. Before proceeding with the following tests, the balance should be warmed up (60 minutes) and calibrated. (See **Appendix A**)

#### 4.4.1 Precision Test

The Precision Test is a quick test that measures the deviation of a limited number of weight readings. If the balance passes the precision test than the following tests should be performed.

**Note:** This is a reference test for approved models (OIML and NTEP). It is not a required test but it can be used to determine if the balance is working properly.

1. The reading on the display should be 0g.
2. Select a mass weighing near the maximum capacity of the balance, and place it on the center of the Pan. Observe and record the reading.
3. Remove the mass. The reading should return to 0g  $\pm$  1d.
4. Repeat this test three times. The readings should be within  $\pm$  1d. If so, the balance passes the Precision Test.

If the deviation for any set of readings (using the same mass placed on the center of the Pan) is greater than 1d, the balance does not meet the precision specification. Inspect and correct the following areas:

- Check for mechanical obstructions. Any foreign object touching any part of the moving assemblies will cause a balance to fail the Precision Test. Inspect and correct as necessary.
- If the balance does not meet specifications, move it to a suitable location, ensure that it is level, and try again. If it still does not meet specifications, perform a service calibration, and try again. (See **Appendix B** for Service Calibration)
- If the balance does not pass this test, the Load Cell may need to be replaced.

#### 4.4.2 Repeatability Test (non-approved models)

The repeatability specification is defined as the Standard Deviation value derived from a set of weight readings. This test uses more weight data than the Precision Test and will allow for occasional weight deviations due to testing variations.

Note: The required method for approved models (OIML and NTEP) is shown in the following section.

##### Requirements:

- To perform this test a single mass must be used for all readings.
- The test mass should be approximately  $\frac{1}{2}$  of the capacity of the instrument.
- Wear gloves when handling the mass.

##### Set Up:

Before starting a repeatability test, set up the instrument as follows.

Enter the service menu (see **Appendix B.1**) and adjust and record the following settings:

- Set the Stability setting to 0.5d (its lowest setting).
- Set the Filter level to "Middle".
- Set the AZT (Auto Zero Tracking) to .5d (its lowest setting). Do not turn it off.

Enter the User Menu (see 1.8.1) and adjust the following settings:

- Set the instrument to display the same units as the performance specifications. (Usually kg, g, or mg)

##### Record Test Parameters:

- Stability Setting = \_\_\_\_\_
- Filter Level Setting = \_\_\_\_\_
- Auto Zero Tracking Setting = \_\_\_\_\_
- Displayed Units = \_\_\_\_\_
- Mass Used = \_\_\_\_\_

##### Test Procedure:

1. Zero the instrument.
2. Using a test mass approximately half the capacity of the instrument, place the mass on the center of platform. Record the reading on the worksheet provided.
3. Remove the mass from the platform.
4. Repeat this test starting at Step 1 until you record a total of ten readings.

**Fill in the worksheet with the ten (10) readings.**

TABLE 4-2: REPEATABILITY WORKSHEET

n	Reading	Delta = Reading – Mean	Delta x Delta
1			
2			
3			
4			
5			
6			
7			
8			
9			
10			

**n** = number of Reading  
**Mean** = Sum of readings / 10  
**Delta** = Reading – Mean  
**Standard Deviation** = Square Root of (sum of (Delta x Delta) / 9)

5. Add the ten readings and divide the total by 10 to find the Mean (average).  
 Mean = (Reading 1 + Reading 2 + Reading 3 + Reading 4 + Reading 5+ Reading 6 + Reading 7+ Reading 8 + Reading 9 + Reading 10) / 10  
**Mean** = \_\_\_\_\_
6. Calculate the Delta for each reading and record in the work sheet.  
**Delta** = Reading – Mean
7. Calculate the Delta x Delta for each reading and record in worksheet.
8. Add the ten Delta x Delta values and divide by 9
9. Calculate the Standard Deviation by applying the square root of the result from step 8.  
**Standard Deviation** = \_\_\_\_\_

**Note:** If the balance does not meet specifications, check environmental conditions, ensure that the balance is level, and try again. If it still does not meet specifications, perform a service calibration, and try again. (See **Appendix B** for Service Calibration)

Repeatability Test – Approved models

This test is a variation of the test above. Rather than determining acceptance based on the standard deviation of the errors, MPE is used. The other variation is that 2 series of weighings are used, one near 50% of max and the other near 100% of maximum capacity.

1. See Table 1-1 to determine the two weight values that must be used.
2. Record 10 reading using each weight value. Zero the balance between each reading if necessary.
3. The difference between the results of the 10 readings must be less than the absolute value of the Maximum Permissible Error (MPE) for the load. The MPE for each load in grams is given in Table 1-1.

**4.4.3 Linearity Test**

This test is used to determine the linearity of the unit throughout its operating range. The masses used to perform this test can be utility masses.

This is a reference test for approved balances as there is no linearity specification. The approved models should be able to pass this test so it is still valid to determine balance performance.

**NOTE:**



The balance must pass the Precision and Repeatability Tests, and be calibrated before the Linearity Test is performed.

**TABLE 4-3 LINEARITY TEST - REFERENCE AND LOAD MASSES**

Model	Reference Mass	Load 1	Load 2	Load 3
EX124	30g	30g	60g	90g
EX224	50g	50g	100g	150g
EX324	75g	75g	150g	225g
EX223	50g	50g	100g	150g
EX423	100g	100g	200g	300g
EX623	150g	150g	300g	450g
EX1103	250g	250g	500g	750g
EX2202	500g	500g	1000g	1500g
EX4202	1000g	1000g	2000g	3000g
EX6202	1500g	1500g	3000g	4500g
EX10202	2500g	2500g	5000g	7500g
EX6201	1500g	1500g	3000g	4500g
EX10201	2500g	2500g	5000g	7500g
EX12001	1500g	1500g	3000g	7500g
EX24001	5000g	5000g	10000g	17500g
EX35001	5000g	5000g	10000g	25000g

**NOTE:** All masses are nominal values. Be certain to use the same reference mass throughout the procedure.

1. Place the Reference Mass on the Balance, record the weight and remove.
2. Place Load 1 on the Balance and press TARE.
3. Place the test mass on the Balance, record the weight and remove.
4. Place Load 2 on the Balance and press TARE.

## CHAPTER 4 - TESTING

5. Place the test mass on the Balance, record the weight and remove.
6. Place Load 3 on the Balance and press TARE.
7. Place the test mass on the Balance and record the weight.
8. The difference in the weights of the test mass should be within the tolerance in Table 4-2. If the differences are out of tolerance, verify the test conditions and repeat the test.
9. If the Balance remains out of tolerance, the Load Cell may need to be replaced.

### 4.4.4 Off-Center Load Test

The Off-Center Load Test is used to determine whether displayed weight values are affected by moving the sample to different areas of the Pan. OCL test may also be referred to as a Shift Test (NTEP) or an Eccentricity Test (OIML).

The test weight used in this test 1/3 the capacity of the balance. See table for the test weight values.

**TABLE 4-4 OFF CENTER LOAD MASS VALUES**

Model	OCL Mass Value	Notes
EX124	50g	1. The class of the weight used in OCL testing is not critical.  2. Use large weights where possible. Smaller weights can be stacked on the larger but a stability problem may occur if many smaller weights are used. If weights cannot be stacked they must be placed uniformly over the segment.
EX224	100g	
EX324, M, N	100g	
EX223	100g	
EX423	200g	
EX623	200	
EX1103, M, N	500g	
EX2202	1000g	
EX4202	2000g	
EX6202	2000g	
EX10202, M, N	3500g	
EX6201	2000g	
EX10201	3500g	
EX12001	4000g	
EX24001	8000g	
EX35001	12000g	

The test positions (A-D) must be centrally located in each segment.

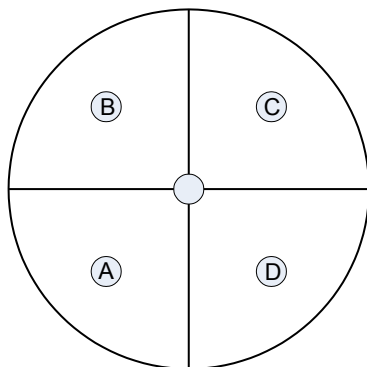

Round Pan

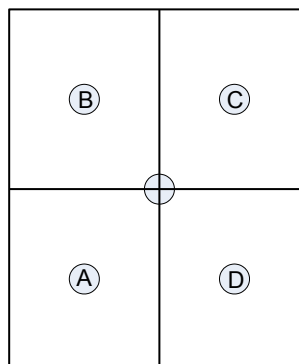

Rectangular Pan



## Procedure:

1. Set AZT (Auto Zero Tracking) to off. This setting is located in Menu - Balance Setup - AZT menu.
2. Place the test weight in the center of the Weighing Pan.
3. Tare the balance.
4. Move the weight to location A and record the reading (when stability indicator comes on).
5. Move the weight to location B and record the reading.
6. Move the weight to location C and record the reading.
7. Move the weight to location D and record the reading.
8. Maximum allowable change in displayed weight readings for each of the four positions can be found in Specifications Tables (Chapter 1). If this maximum is exceeded verify the test conditions and retest the balance. If there is no improvement the load-cell must be replaced.

Note: In high resolution balances (Class I) it may be necessary to zero or tare between each location.

### 5 PARTS LISTS & DIAGRAMS

This section of the manual contains parts lists and exploded views for the Explorer® balances. These are designed to identify the parts which can be serviced on the balance in the field. The parts list and exploded views are separated into separate sections for the Terminal, the Base and the Draftshield.

To order spare parts, identify the required item in the exploded views and parts list, then use the Spare Parts List to obtain the current part number for this item.

**NOTE:** In all cases where a part is replaced, the balance must be thoroughly checked after the replacement is made. The balance **MUST** meet the parameters of all applicable specifications in this manual.

If further technical information is needed, please contact your local Ohaus office, or [www.ohaus.com](http://www.ohaus.com).

5.1 TERMINAL SPARE PARTS

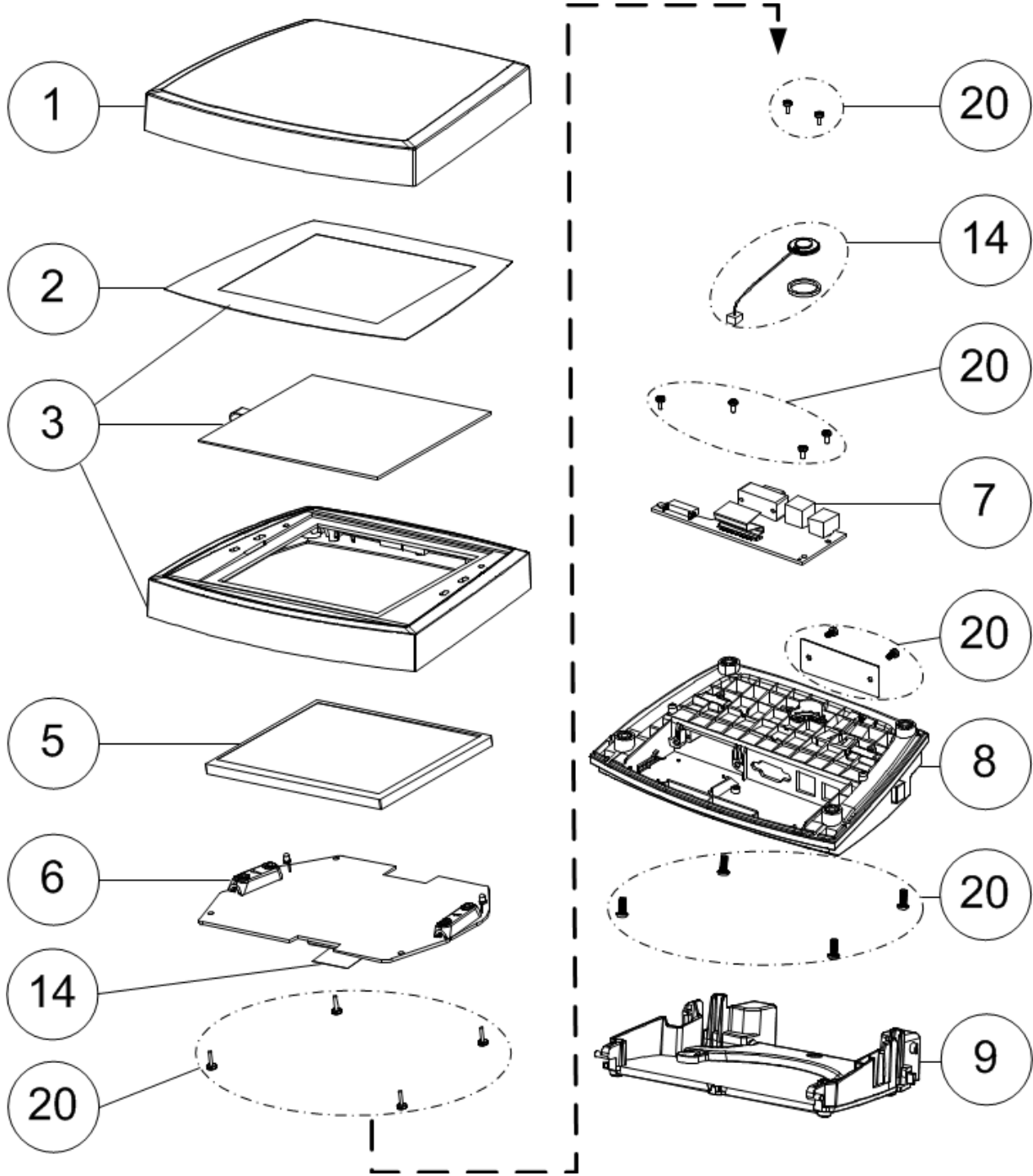

**TABLE 5-1 TERMINAL SPARE PARTS**

<b>Item</b>	<b>Description</b>	<b>Part Number</b>
2	Function Label EX	83033626
3	Top Housing Assembly, Terminal EX	30019590
5	Display, LCD EX	83033622
6	PCB, Main, Terminal EX	83033620
7	PCB Interconnect, Terminal EX	83033621
8	Bottom Housing, Terminal EX	83033628
9	Bracket Assembly, Terminal EX	83033625
14	Cable Kit, Terminal EX	83033630
20	Hardware Kit, Terminal EX	83033631
All	Terminal, Complete EX	83033632

5.2 BASE SPARE PARTS (Non-Draftshield models)

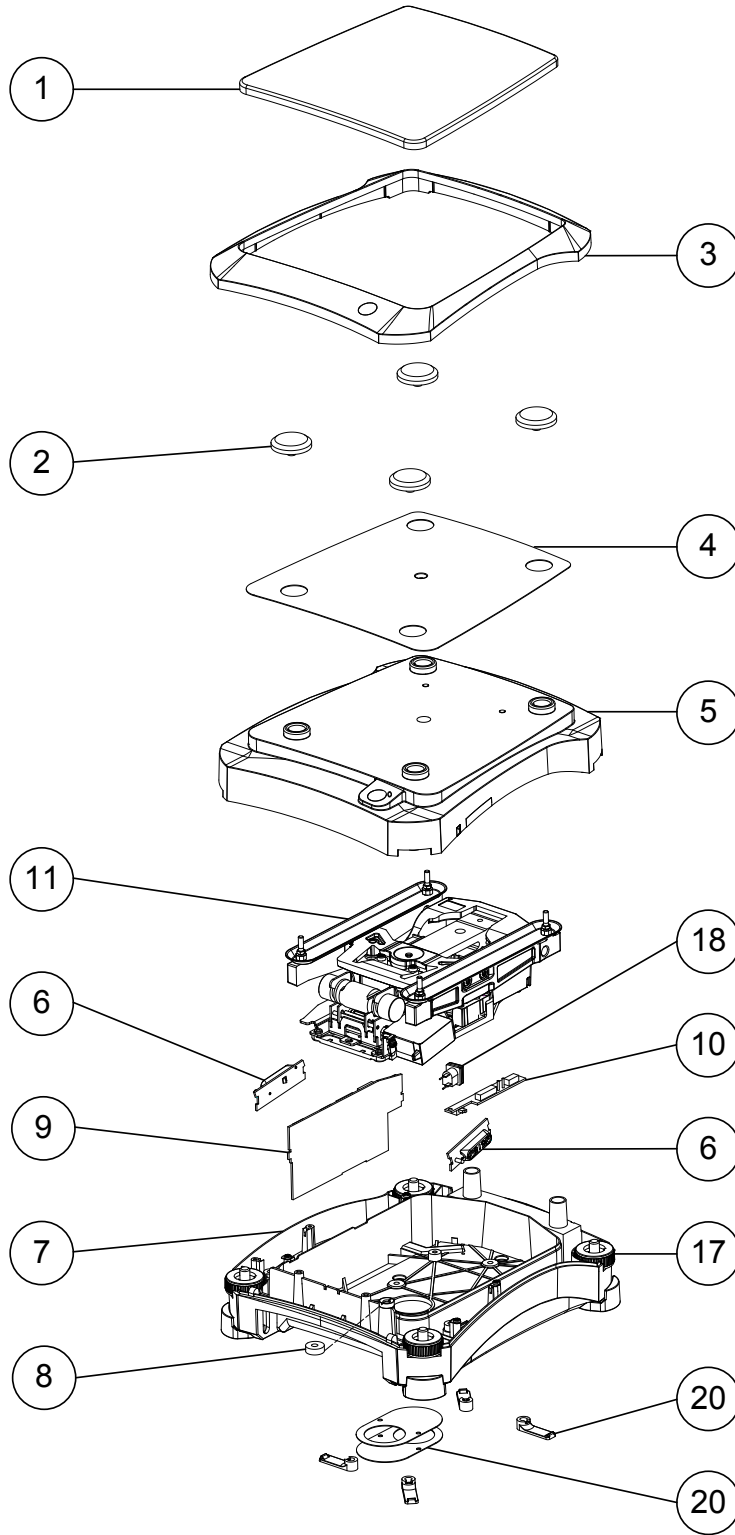

**TABLE 5-2 BASE SPARE PARTS (NON-DRAFTSHIELD MODELS)**

<b>Item</b>	<b>Description</b>
1	Pan, Rectangular
2	Pan Support, Rectangular (4)
3	Windshield, Rectangular
4	EMC Plate
5	Top Housing, Non-DS
6	IR Sensor PCBA
7	Base, Non-DS
8	Level Bubble
9	Main PCBA
10	Connect PCBA
11	Load-cell
17	Foot Kit
18	Cable Kit (not all shown)
20	Hardware Kit (not all shown)
Not shown	Box, Non-DS
Not shown	Packaging Complete, Non-DS

5.3 BASE SPARE PARTS (Draftshield models)

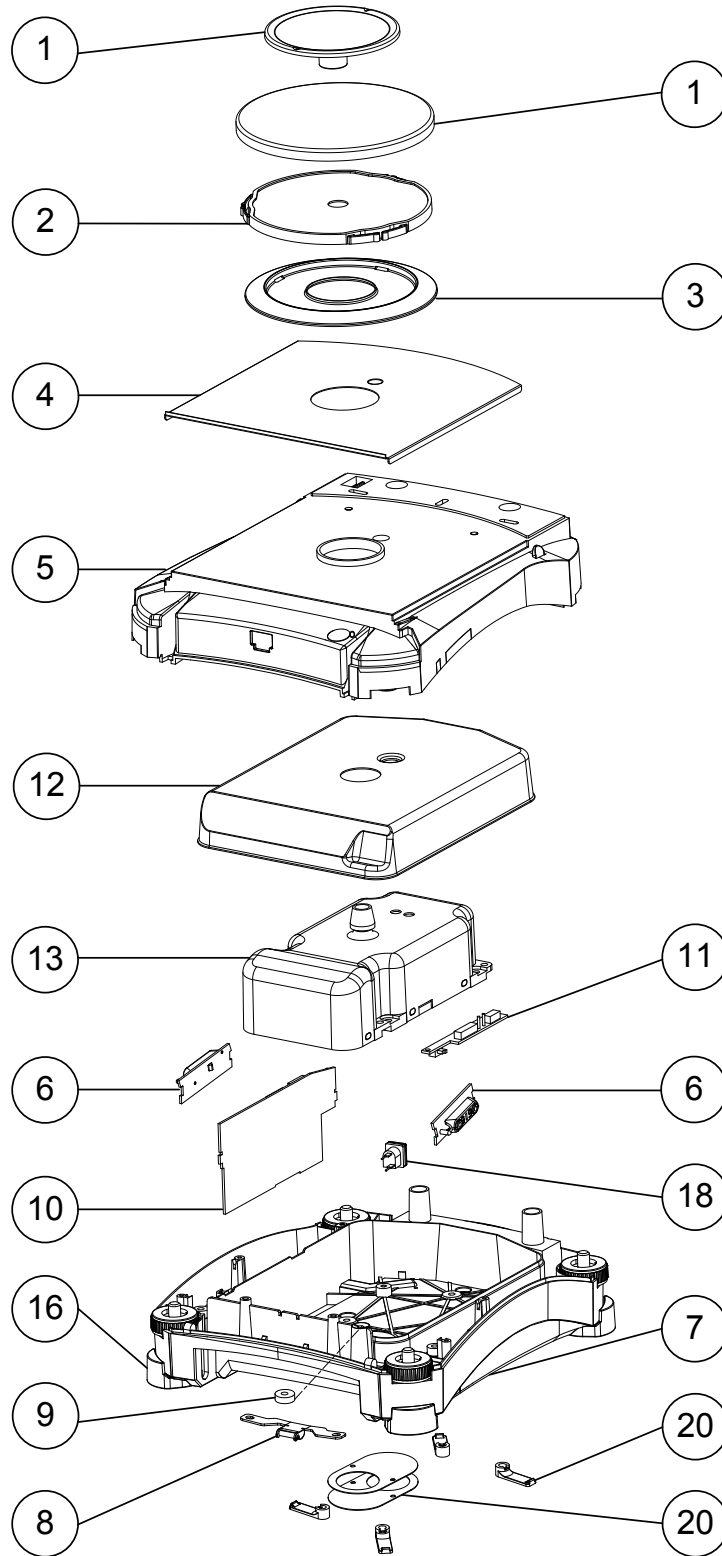
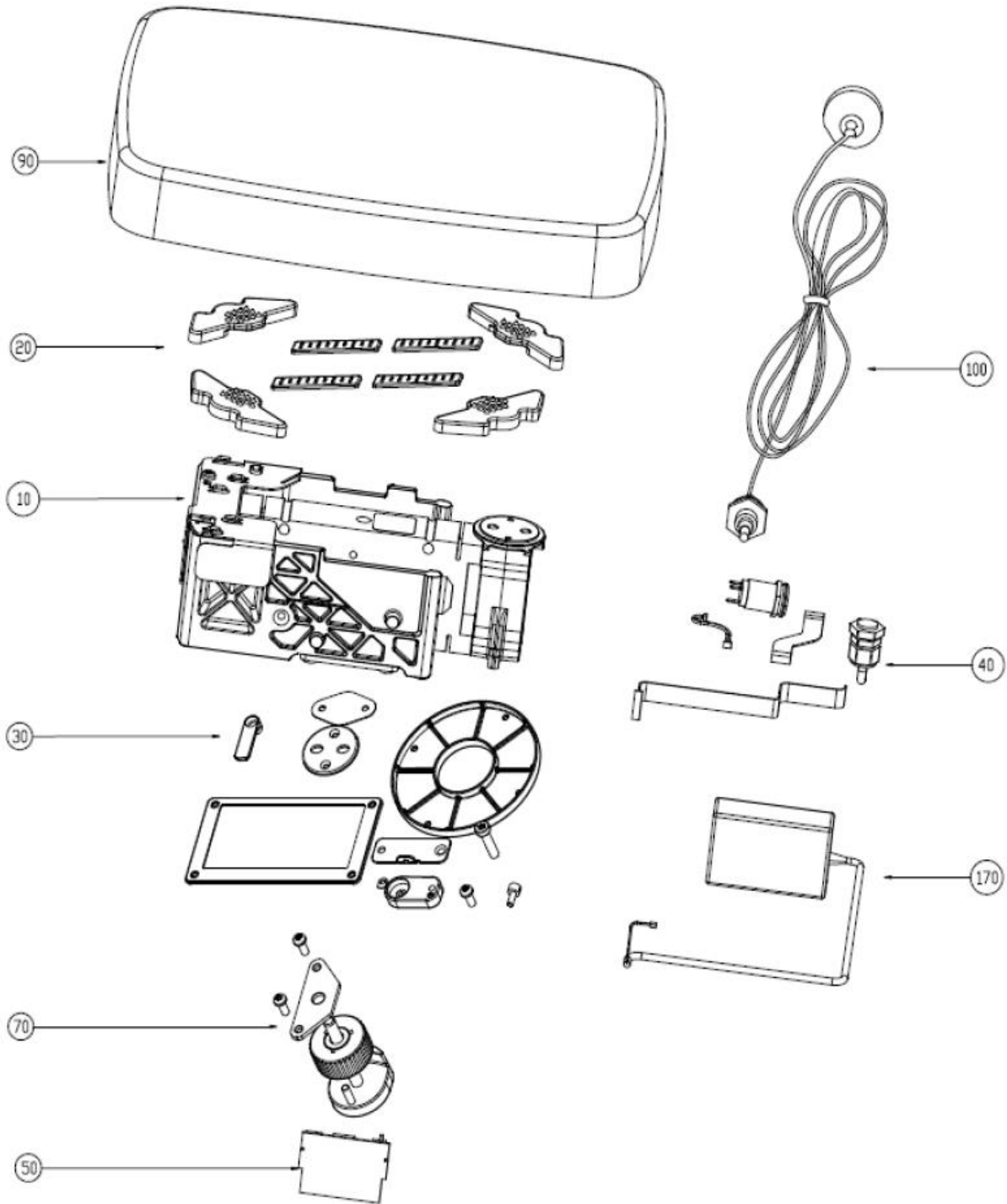

**TABLE 5-3 BASE SPARE PARTS (DRAFTSHIELD MODELS)**

<b>Item</b>	<b>Description</b>
1	Pan, 90mm
1	Pan, 130mm
2	Pan Support, 130mm
3	Wind-ring, 90mm
4	EMC Plate - DS
5	Top Housing, DS
6	IR Sensor PCBA
7	Base
8	Latch, Front Panel
9	Level Bubble
10	Main PCBA
11	Connect PCBA
12	Load-cell Cover
13	Load-cell
16	Foot Kit
18	Cable Kit (not all shown)
20	Hardware Kit (not all shown)
Not shown	Box, DS
Not shown	Packaging Complete, DS



5.4 BASE SPARE PARTS (EX12001, EX24001, EX35001)



**CHAPTER 5 - PARTS LISTS & DIAGRAMS****TABLE 5-4 BASE SPARE PARTS (EX12001, EX24001, EX35001)**

Drawing Item	Part Number	Description
10	30076252	SP MFR Loadcell 35kg, EX HiCap
20	30076187	SP Pan support Assembly EX HiCap
30	30076188	SP Screws kit, EX HiCap
40	30076189	SP Cables kit, EX HiCap
50	30076250	SP PCBA, LFT, EX HiCap
70	30076276	SP Adjustable foot EX HiCap
90	30076186	SP Larger Pan EX HiCap
100	30041267	SP Power-Cord US EX HiCap
110	30041462	SP Power-Cord EU EX HiCap
120	30041463	SP Power-Cord CN EX HiCap
130	30041464	SP Power-Cord UK EX HiCap
140	30041465	SP Power-Cord AU EX HiCap
150	30041466	SP Power-Cord JP EX HiCap
160	30041469	SP Power-Cord KR EX HiCap
170	30041419	SP Power adapter EX HiCap
NA	30076295	SP Packaging Assembly EX HiCap
NA	30041271	Shipping Box EX HiCap

5.5 DRAFTSHIELD SPARE PARTS

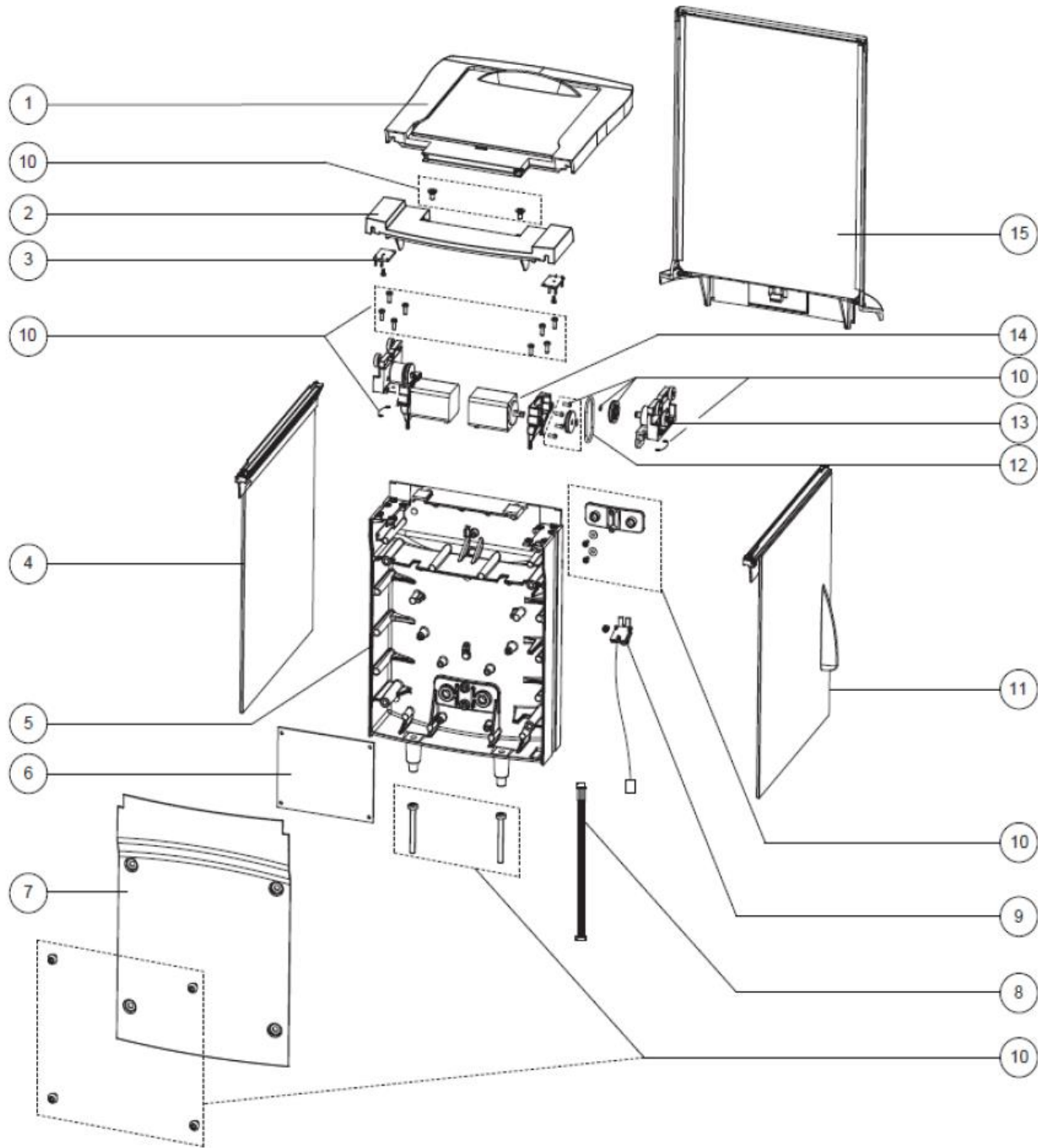

**TABLE 5-5 DRAFTSHIELD SPARE PARTS**

<b>Item</b>	<b>Description</b>	<b>Part Number</b>
1	Slide Door Top DS EX	30069153
2	Top Cover Backwall EX	83033684
3	PCBA Door Sensor EX	30069155
4	Glass Assy – Right EX	83033679
5	Backwall EX	83033681
6	PCBA Motordriver Board EX	30069154
7	Shield Cover Backwall EX	83033682
8	Cable Kit EX	83033656
9	Light Assy DS EX	83033687
10	Hardware DS EX	83033688
11	Glass Assy – Left EX	83033678
12	Belt DS EX	30066394
13	Bracket Assy EX	83033625
14	Motor Step DS EX	30069152
15	Glass Assy – Front EX	83033677

## APPENDIX A - USER CALIBRATIONS

### A.1 SPAN CALIBRATION

The InCal system in Explorer® balances will perform a good span calibration as long as there is no damage to the load-cell. Verification with an external weight should be done if there is a question of the balances accuracy. Often any weight variations are due to the inaccuracy of the external calibration weight rather than a calibration error with the InCal system.



Touch **Internal Calibration** to initiate a calibration using the internal weight.

If an external calibration is required due to the customer's audit system follow the procedure in the Instruction Manual or the copy below. See Section 4.1 for Calibration Masses required for each model.

**Note:** This menu is locked out in Legal for Trade applications. To regain access, see Section 1.7.



With the balance turned ON and no load on the pan, touch **Menu** then **Calibration** and then **Span Calibration** to initiate the procedure. When complete, the display shows the Span calibration status and returns to the current application.

**Note:** To change the span calibration point, touch the alternate weight shown on the display. Follow the screen instructions and place the specified calibration weight on the scale when prompted to do so.

**NOTE:** If calibration fails, ensure that the test area is free from drafts and the surface the balance rests on is level and free of vibrations. Then try to calibrate again. If it continues to fail, there may be an internal problem. To resolve internal problems, follow procedures in Chapters 2 and 3.



Be careful not to touch the balance or the table while calibration is in progress, as it will cause the process to fail.

## A.2 LINEARITY CALIBRATION

The Explorer® balances do not have user linearity calibration.

Section 4.4.4 has the procedure to determine if the balance linearity is within specification. See **Appendix B** for the Service Linearization procedures.

## A.3 TOUCH SCREEN CALIBRATION

The Touch Screen needs to be re-calibrated if the screen does not respond correctly to intended commands. A Touch Screen calibration is required if the Touch Screen or Main PCBA is replaced.



With the balance turned ON, touch **Menu** then **User Settings** then **Display Settings** and then **Touch Calibrate**.

**Touch Calibrate:** “Touch the screen at the center of the ring. **O** Press here.”  
(First top-left, then bottom-right)

**APPENDIX B - DIAGNOSTIC / SERVICE MENU**

This appendix describes the Diagnostic Menu and the limited access Service Menu. From the main screen touch **Menu**, scroll down then touch **Diagnostics** to enter the menu.

**B.1 User Accessible Diagnostics**

The first three selections can be accessed by the user. The Service Menu is only to be used by Service Technicians and is discussed in the next section.

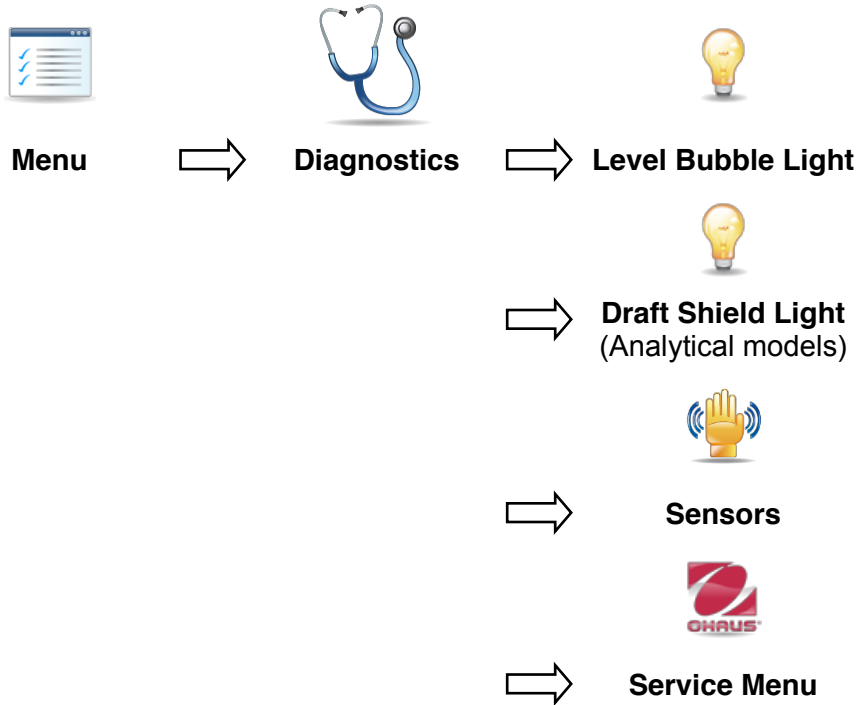

**Level Bubble Light**

To verify proper operation of the illuminated Level Bubble touch the icon and the light should blink. If the light does not blink verify that the wiring is okay. Check for the evidence of pinched wiring as this is a likely cause. If the wiring is okay, verify the voltage (3.3 VDC) at the LED connector pins on the PCBA.

**Draft Shield Light (Analytical models)**

To verify proper operation of the Draft Shield Light touch the icon and the light should blink. If the light does not blink verify that the wiring is okay. Check for the evidence of pinched wiring as this is a likely cause. If the wiring is okay, verify the voltage (5 VDC) at the connection pins on the DS Light PCBA.

**Sensors**

This tool is used to verify proper operation of each Touchless Sensor. When operated, each sensor should light and make a sound. If the sensor is not operating verify the wiring is okay. Check for the evidence of pinched wiring as this is a likely cause. If the wiring is okay verify that voltage (3.3 VDC) is reaching the Sensor PCBA, pins 2 and 4.

**Service Menu**

The Service Menu is intended for use by service personnel only. A password is required to access this menu, see the next section.

**B.2 Service Sub-Menu**

The Service sub-menu, allows authorized service personnel to monitor **Ramp** or perform a variety of service weight calibrations. A password is required to access this menu. The current password is “Explorer” (SW: 1.10) and “OHAUS” (SW: 1.03). Software in the initial production units may not have all of the service items shown.

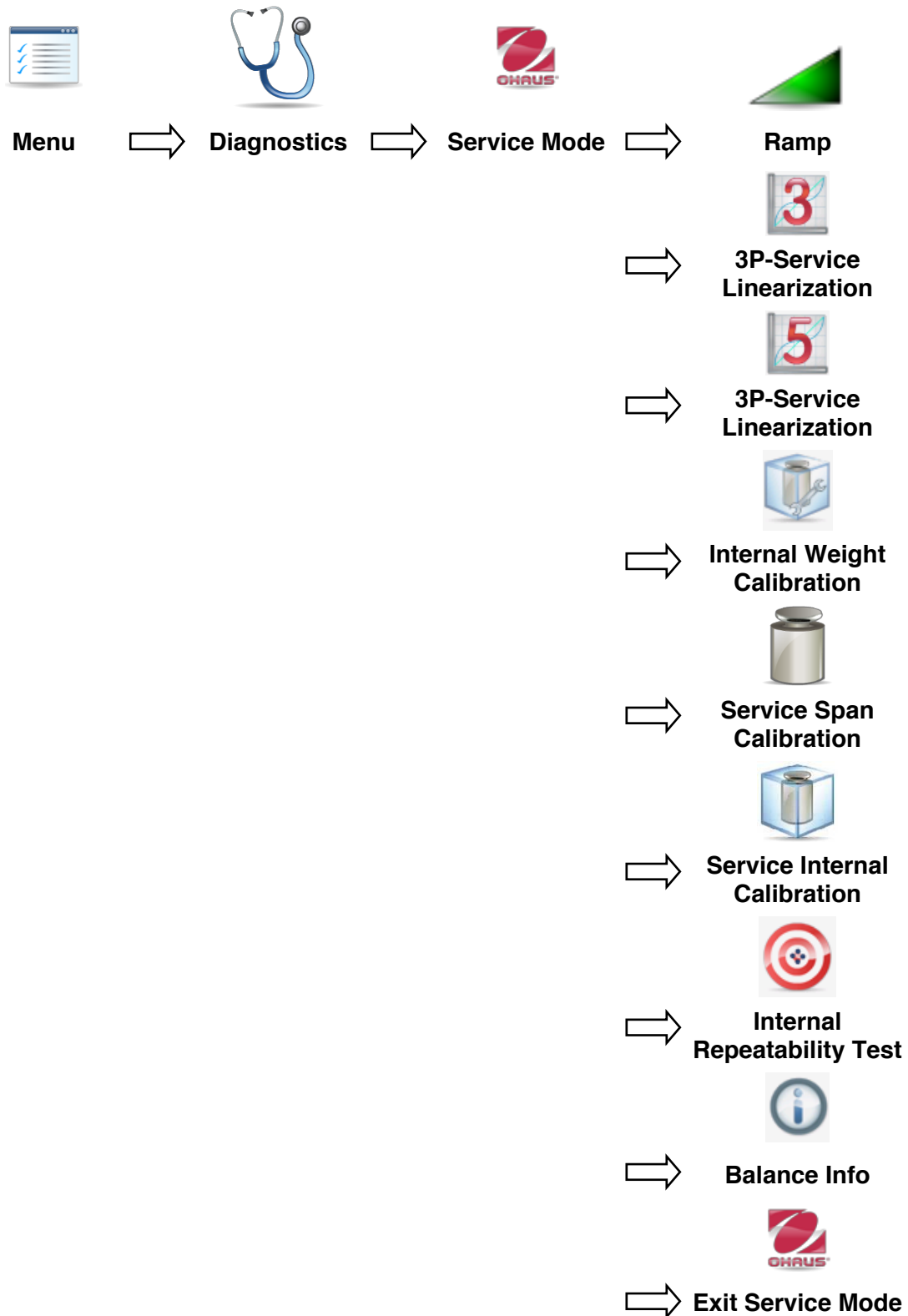



**RAMP**

The ramp display shows the percentage of use of the A to D circuit, that is, of the temperature-compensated duty cycle. The actual value is not as important as how it changes. It should increase as the weight on the balance is increased. The ramp display should remain constant without fluctuations.

The normal range is within 3% to 97%. If the readings are outside this range the load-cell is likely bad. Fluctuations in the display may indicate a mechanical interference, a cable connection problem, a damaged Main PCB or a damaged load-cell.

**3 Point- LINEARITY CALIBRATION**

A three point linearization is also rarely required and is difficult to perform accurately under the less than ideal conditions outside the factory. This service calibration requires that accurate calibration weights be used. Calibration points are done at approximately 0, 50% and 100% of maximum capacity. After the linearization procedure the balance will automatically start a Service Span calibration and then a Service Internal Calibration.

The sequence of loading the test weights on the platform is very important to insure a correct linearity calibration. Refer to the diagram below for the correct weight sequence.

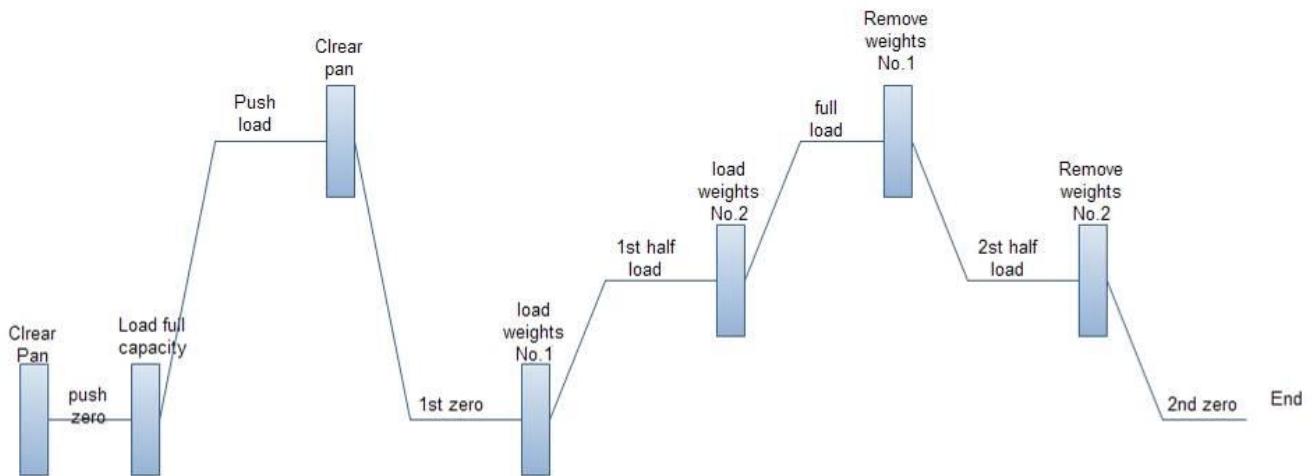

### 5 Point- LINEARITY CALIBRATION

A five point linearization is rarely required and is the most difficult to perform accurately under the less than ideal conditions outside the factory. This service calibration requires that accurate calibration weights be used. Calibration points are done at approximately 0, 25%, 50%, 75% and 100% of maximum capacity.

The sequence of loading the test weights on the platform is very important to insure a correct linearity calibration. Refer to the diagram below for the correct weight sequence. Load each numbered weight (or group of weights if required) in the order indicated (No.1, No.2, No.3, No.4) then remove in the correct order (No.1, No.4, No.2, No.3). This is done to reduce the affect of the individual weight inaccuracies on the linearity calibration.

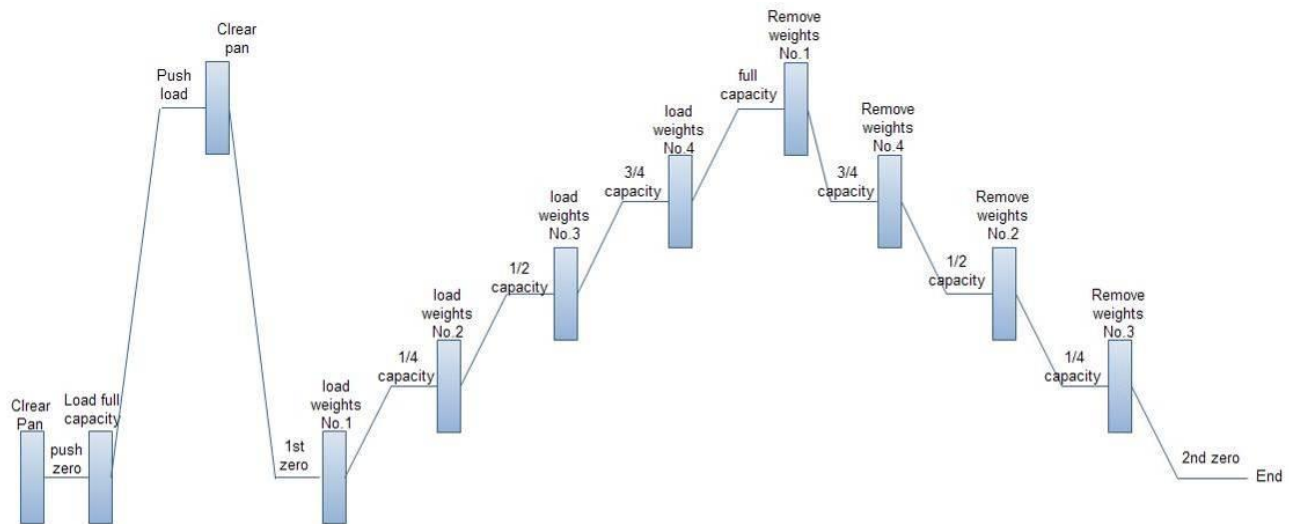

### INTERNAL WEIGHT CALIBRATION

Internal weight calibration in the Service Menu is used to determine the balance's internal weight. This establishes a ratio between the internal weight and an external calibration weight.

### SERVICE SPAN CALIBRATION

Service span calibration allows a new zero and maximum setting using an external calibration weight.

### SERVICE INTERNAL CALIBRATION

The internal calibration weight is used to calibrate the balance.

If a pan, pan support or load-cell is changed a Service Span Calibration or Service Internal Calibration should be done.

**INTERNAL REPEATABILITY TEST**

The internal weight is used to determine the repeatability of the load-cell. The standard deviation is determined after 10 cycles of the internal weight.

**TABLE B-1 SERVICE CALIBRATION MASS VALUES**

Model	Span	3-P Lin	5-P Lin	Weight Class	
EX124	100g	50g, 100g	25g, 50g, 75g, 100g	ASTM Class 1	OIML E2
EX224	200g	100g, 200g	50g, 100g, 150g, 200g	ASTM Class 1	OIML E2
EX324, M, N	300g	150g, 300g	75g, 150g, 225g, 300g	ASTM Class 1	OIML E2
EX223	200g	100g, 200g	50g, 75g, 100g, 200g	ASTM Class 1	OIML E2
EX423	400g	200g, 400g	100g, 200g, 300g, 400g	ASTM Class 1	OIML E2
EX623	600g	300g, 600g	150g, 300g, 450g, 600g	ASTM Class 1	OIML E2
EX1103, M, N	1000g	500g, 1000g	250g, 500g, 750g, 1000g	ASTM Class 1	OIML E2
EX2202	2000g	1000g, 2000g	500g, 1000g, 750g, 2000g	ASTM Class 1	OIML E2
EX4202	4000g	2000g, 4000g	1000g, 2000g, 3000g, 4000g	ASTM Class 1	OIML E2
EX6202	6000g	3000g, 6000g	1500g, 3000g, 4500g, 6000g	ASTM Class 1	OIML E2
EX10202, M, N	10,000g	5000g, 10000g	2500g, 5000g, 7500g, 10000g	ASTM Class 1	OIML E2
EX6201	6000g	3000g, 6000g	1500g, 3000g, 4500g, 6000g	ASTM Class 2	OIML F1
EX10201	10,000g	5000g, 10000g	2500g, 5000g, 7500g, 10000g	ASTM Class 1	OIML E2
EX12001	12,000g	3000g, 12,000g	1500g, 3000g, 7500g, 12,000g	ASTM Class 2	OIML F1
EX24001	24,000g	10,000g, 24,000g	5000g, 10,000g, 17,000g, 24,000g	ASTM Class 1	OIML F1
EX35001	35,000g	10,000g, 35,000g	5000g, 10,000g, 22,500g, 35,000g	ASTM Class 1	OIML F1

**Balance Info**

Contains information about the balance including:

Balance Type, Max, d, Balance ID, IDNR, Loadcell Type, Loadcell Serial Number, Terminal Serial Number, Terminal SW Version, Base SW Version.

**Exit Service Mode**

Exits the Service Mode and returns to Normal Mode.

**APPENDIX C – SERVICE TOOL**

The Software Service Tool (Part Number 83032124) is required when a main PC Board is replaced in a Explorer® balance. It is used to re-configure the balance to its original parameters in the case of a PCB replacement. The tool can also be used to communicate with the balance using commands that are listed at the end of the appendix.

The latest software service tool and support files are available on the Ohaus DMX site.

Please read the Service Tool Instruction Manual (Part Number 30032352) which is also available on Ohaus DMX site.

**C.1 Balance Commands**

The balance commands are used to send instructions to the balance. Commands listed in the following table will be acknowledged by the balance. The balance will return “ES” for invalid commands.

**TABLE C-1 INTERFACE COMMAND LIST**

<b>Command</b>	<b>Function</b>
IP	Immediate Print of displayed weight (stable or unstable). Attention: when LFT ON, IP could only print stable displayed weight.
P <sup>1)</sup>	Print displayed weight according to “Stable only” setting in the communication menu. Attention: when LFT ON, P could only print stable displayed weight.
CP	Continuous Print. Attention: when LFT ON, CP could not work.
SP <sup>1)</sup>	Print on Stability.
SLP	Auto Print stable non-zero displayed weight. Attention: the corresponding settings in the communication menu are modified too.
SLZP	Auto Print stable non-zero weight and stable zero reading. Attention: the corresponding settings in the communication menu are modified too.
xP	Interval Print x = Print Interval (1-3600 sec) 0P ends interval Print. Attention: the corresponding settings in the communication menu are modified too.
0P	See above.
H	Enter or get Print Header Lines. Header text length is up to 20 characters, the setting format is “H x “header line text””; and “H x” could get the corresponding header line in the balance.
Z	Same as pressing Zero Key
T	Same as pressing Tare Key.
xT	Establish a preset Tare value in displayed unit. X = preset tare value. Sending 0T clears tare (if allowed).
PT	Prints Tare weight stored in memory.
PM	Print current application mode (weighing mode).
xM	Set current application mode to x. x depends on application, use application list <sup>2)</sup> .
M	Scroll to the next enabled mode.
PU	Print Current weighing unit: g, Kg, lb, oz, etc....
xU	Set balance to unit x: g, Kg etc. x depends on unit list <sup>3)</sup> .
U	Scroll to the next enabled unit.
ON	Brings out of Standby
OFF	Goes to Standby.
C	Begin Span Calibration, same as trigger from calibration menu. Attention: when LFT ON, the operation is not allowed.
IC	Begin internal Calibration, same as trigger from calibration menu.
UC	User Calibration (uses default weight), same as trigger from calibration menu. Attention: when LFT ON, the operation is not allowed.
AC	Abort Calibration. Attention: when LFT ON, the operation is not allowed.
xUC	Set user defined weight and trigger one user calibration. The user defined weight is only used for this command.
PSN	Print Serial Number.
PV	Print base software version, terminal software version and LFT ON (if LFT is set ON).
x#	Set Counting APW (x) in grams. (must have APW stored)
P#	Print Counting application APW.

## APPENDIX C - SOFTWARE SERVICE TOOL INSTRUCTIONS

**TABLE C-1 INTERFACE COMMAND LIST (CONTINUED)**

Command	Function
x%	Set Percent application reference weight (x) in grams. (must have reference weight stored)
P%	Print Percent application reference weight.
xAW	Set Dynamic Weigh Level to x. (x = 1 - 99 seconds)
xAW	Set Dynamic Weigh Mode. x = A (Automatic), S (Semi-Automatic), M (Manual)
PAW	Print Dynamic Weigh Level.
BAW	Start Dynamic Weigh cycle. (Manual Mode)
CW	Clear locked weight (weight < threshold) in Dynamic Weigh, Display Hold & Totalize.
xCO	Set Checkweighing Over Limit in grams x.
xCU	Set Checkweighing Under Limit in grams x.
PCO	Print Checkweighing Over Limit.
PCU	Print Checkweighing Under Limit.
xCM	Set Checkweigh mode (1=over/under, 2=target/% tolerance, 3=Target/weight tolerance)
xCT%	Set Checkweighing target in grams x for percent tolerance mode.
PCT%	Print Checkweighing Target for percent tolerance mode.
xCTW	Set Checkweighing target in grams x for weight tolerance mode.
PCTW	Print Checkweighing Target for weight tolerance mode.
xC%	Set Checkweighing % tolerance x. Attention: when x is a positive value, it is used to set the +tolerance value; vice versa.
PC%	Print Checkweighing % tolerance.
xCW	Set Checkweighing weight tolerance x. Attention: when x is a positive value, it is used to set the +tolerance value; vice versa.
PCW	Print Checkweighing weight tolerance.
xDH	Set Display Hold mode (Peak Hold). x = A (Automatic), S (Semi-Automatic), M (Manual)
xD	Set 1 second print delay (set x = 0 for OFF, or x = 1 for ON).
xFL	Set filter level to x (1 = low, 2 = med, 3 = high).
xAL	Set Auto-zero to x (x = 1 for 0d, x = 2 for 0.5d, x = 3 for 1d, x = 4 for 3d).
Esc R	Resets all Balance menus to factory defaults. Attention: The binary code of this commands is "1B 20 52 0D 0A" or "1B 52 0D 0A".
PID	Print current user Name.
xID	Program user Name. Attention: only allowed numeric input.
xTL	Set Totalize Mode. x = A (Automatic), M (Manual).
PTIME	Print current time.
PDATE	Print current date.
xTIME	Set Time, x format: hh:mm:ss.
xDATE	Set Date, x format: mm/dd/yyyy.
CA	Continuous weight, same as CP.
SA	Stable load, same as SLP.
xA	Interval Print x = interval in sec (1-3600) 0 = off, same as xP.
0A	Set AutoPrint off, same as 0P.
SC	Begin Span Cal, same as C.
xAM	Set Animal Mode to Auto, Semi-Auto, Manual. Same as xAW(A/S/M)
?	Prints current mode, same as PM.
xS	0 = print unstable data, same as IP; 1 = print stable only <sup>1)</sup> , same as SP.
xRL	0 = disable response; 1 = enable response. Attention: this command only controls the "OK!" response.

**General Notes:**

- Commands sent to the indicator must be terminated by a carriage return (CR) or a carriage return-line feed (CRLF).
- Alternate command characters may be defined by the user.
- Data output is always terminated with a carriage return-line feed (CRLF).
- There is 40-second timeout control for print under stable requirement. If the unstable condition continues over 40 seconds, balance will respond "ES".

**Note 2: Application list**

Index	Application	Index	Application
0	Weighing	11	Pipette Adjustment
1	Parts Counting	12	Ingredient Adjustment
2	Percent Weighing	13	SQC
3	Check Weighing		
4	Dynamic Weighing		
5	Filling		
6	Totalization		
7	Formulation		
8	Differential		
9	Peak Hold		
10	Density Determination		

**Note 3: Unit list**

Index	Unit	Index	Unit
0	g	11	dwt
1	kg	12	mo
2	t	13	msg
3	mg	14	HKt
4		15	SGt
5	ct	16	TWt
6	N	17	tical
7	lb	18	tola
8	oz	19	baht
9	ozt	20	
10	GN	21	custom_1
		22	custom_2
		23	custom_3

### C.2 RS232 (DB9) Pin Connections

- Pin 2: Balance transmit line (TxD)
- Pin 3: Balance receive line (RxD)
- Pin 5: Ground signal (GND)
- Pin 7: Clear to send (hardware handshake) (CTS)
- Pin 8: Request to send (hardware handshake) (RTS)

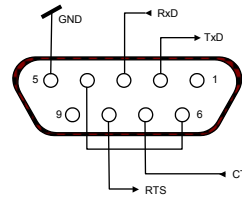

### C.3 USB Interface

The Ohaus USB Interface is a unique solution to the problem of connecting a balance to a computer using a Universal Serial Bus (USB). USB devices are categorized into classes such as disk drives, digital cameras, printers, etc. Balances do not have a commonly used class so the Ohaus USB interface uses a generic interface based on the RS232 serial standard.

Data sent from the balance to a computer is in USB format. The USB data is directed to a virtual port. This port then appears as an RS232 port to the application program.

When sending a command from a computer to the balance, the application program sends a command to the virtual port as if it were an RS232 port. The computer then directs the command from the virtual port to the computer's USB connector where the balance is connected. The port receives the USB signal and reacts to the command.

The USB Interface includes a CD with the software drivers to create the required virtual port on the computer.

#### 3.1. System Requirements

- PC running Windows 98<sup>®</sup>, Windows 98SE<sup>®</sup>, Windows ME<sup>®</sup>, Windows 2000<sup>®</sup>, Windows XP<sup>®</sup> or Windows 7<sup>®</sup>
- Available USB port (Type A, 4-pin, female)

#### 3.2. USB Connection

- 3.2.1. The balance's USB port terminates with a 4-pin, female, USB Type B connector. A USB Cable (type B/male to type A/male) is required (not supplied).
- 3.2.2. Ensure that the balance is powered on and working properly.
- 3.2.3. Power on the computer and verify that its USB port is enabled and working properly.
- 3.2.4. Plug the cable's USB connectors into the computer's USB port and the balance's USB port. Windows<sup>®</sup> should detect a USB device and the New Hardware Wizard will be initialized.

#### 3.3. Virtual Port Software Installation

- 3.3.1. Insert the supplied CD into the computer's CD drive. Different versions of Windows<sup>®</sup> have slightly different steps to load the driver that is on the CD. In all versions the New Hardware Wizard guides you through the required steps to select the driver that is located on the CD.





Example of Windows XP Hardware Wizard

- 3.3.2. After clicking Finish, the virtual port should be ready for use. Windows® typically adds the virtual port in sequence after the highest number COM port. For example, on PC's equipped with up to 4 COM ports, the virtual port will be COM5.
- 3.3.3. When using the USB interface with programs that limit the number of COM port designations (e.g. Ohaus MassTracker allows only COM1, 2, 3, & 4), it may be necessary to assign one of these port numbers to the new virtual port. This can be done in the Port Settings of the Device Manager utility, found in the Windows Control Panel

3.4. Balance Setup for USB interface

- 3.4.1. The Ohaus Interface is preset to communicate using the following settings: 2400 baud, 7 bit, no parity, no handshake. To use different settings, it will be necessary to change either the balance settings, or the computer settings.
- 3.4.2. Configure the balance to the desired USB and printing parameters.

<p><b>PRINT</b></p> <p>Stable On, Off</p> <p>A-Print Cont, On.Stbl, On.Acc*, 5sec, 15sec, 30sec, 60sec, off</p> <p>End Yes, No</p> <p>*Note: Print and USB menu selections may vary between the different balance series.</p>	<p><b>USB</b></p> <p>USB On / Off</p> <p>Baud 600, 1200, 2400, 4800, 9600, 19200</p> <p>Parity 7-even, 7-odd, 7-none, 8-none</p> <p>Handshake None, Xon-Xoff, RTS-CTS</p> <p>END Yes, No</p>
---	--



### APPENDIX D – FIRMWARE UPGRADE VIA USB

From version 2.00 the Explorer firmware can be upgraded via a USB flash drive. The whole process takes less than 10 minutes.

Please follow below steps to upgrade the firmware using a USB flash drive.

#### STEPS

1. Copy the EX\_FWUPD folder to the root directory of the USB flash drive.

**Note:** Do not change the folder name. It needs to be EX\_FWUPD.

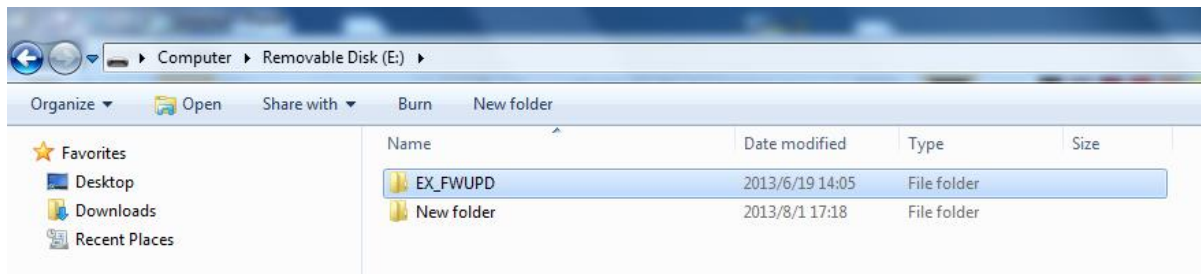

The EX\_FWUPD folder contains three files:

Base.mot – image file for the base unit

setup.ini – setup file

Terminal.bin – image file for the terminal unit

**Note:** Do not change any of the file names.

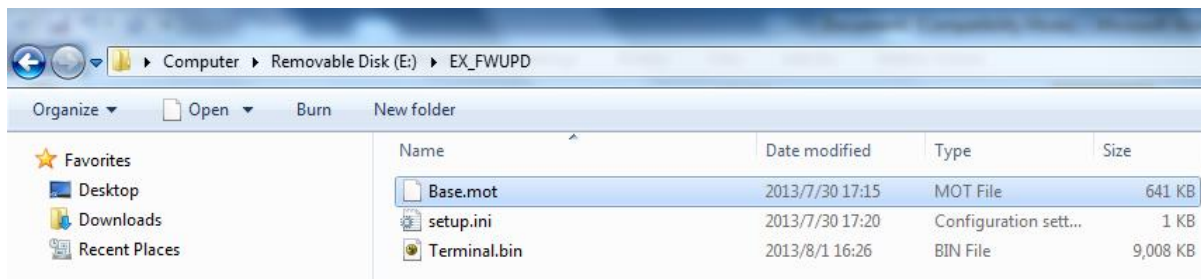

2. Turn on the balance and connect the USB flash drive to the USB host slot on the back of the terminal.

3. Go to User Menu ➡ Diagnostics ➡ Data Maintenance ➡ Software update

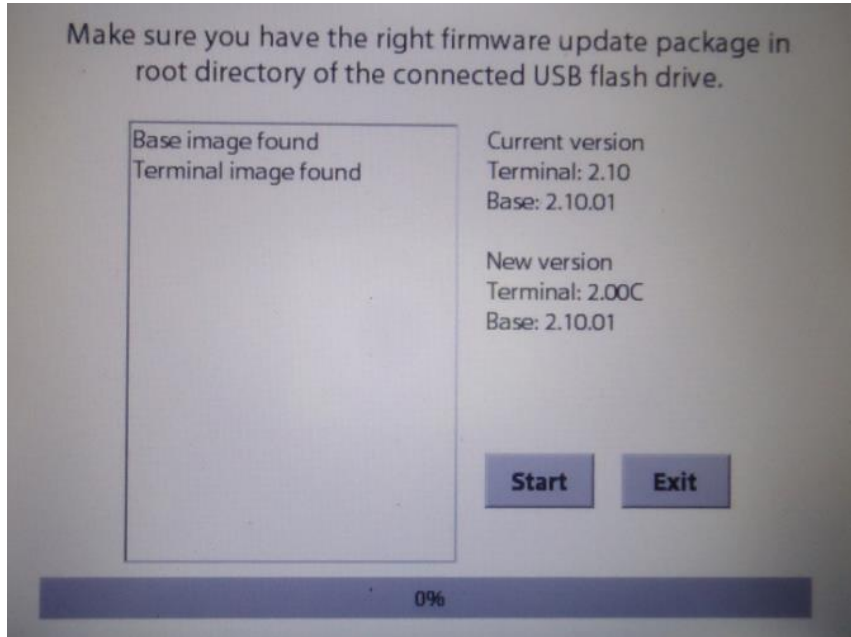

4. Press **[Start]** button to start the upgrade process.

**Note:** Keep the USB flash drive connected and make sure the power is balance power is ON during the entire upgrade process.

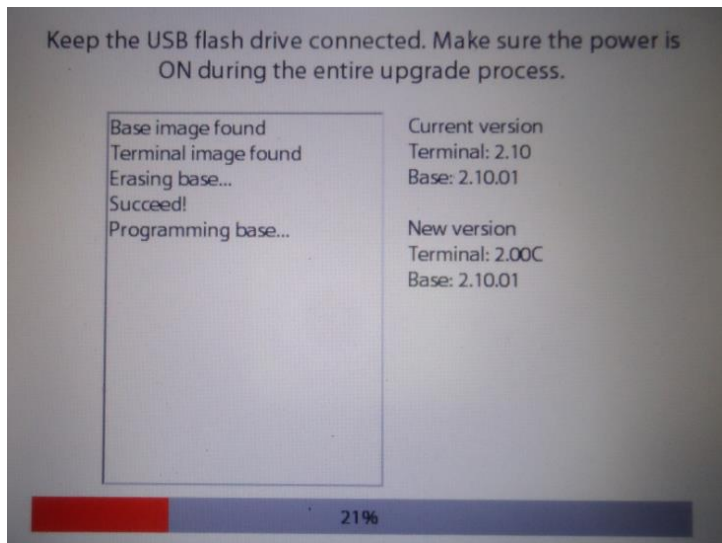

## APPENDIX D – FIRMWARE UPGRADE VIA USB

---

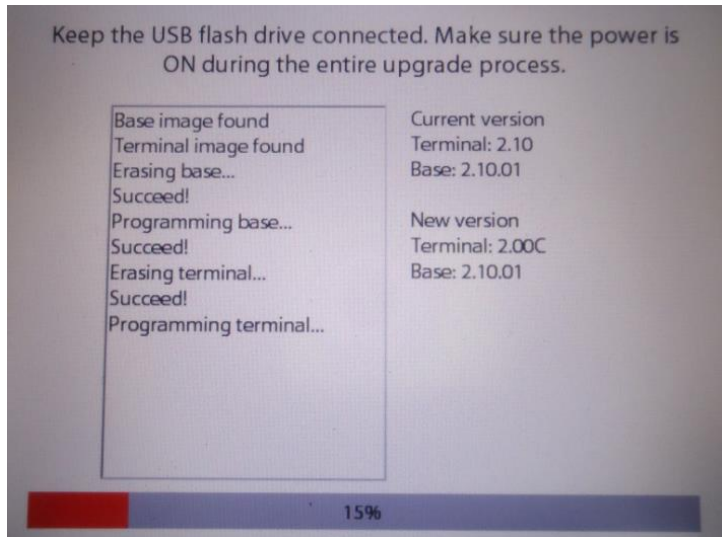

5. Wait approximately 10 minutes for the process to finish.
6. Restart the balance



**Ohaus Corporation**

**[www.ohaus.com](http://www.ohaus.com)**



P/N 83034234 C © 2013 Ohaus Corporation, all rights reserved  
™ Registered trademark of Ohaus Corporation.

The information contained in this manual is believed to be accurate at the time of publication, but Ohaus Corporation assumes no liability arising from the use or misuse of this material. Reproduction of this material is strictly prohibited.

Material in this manual is subject to change.